

Modeling and Fuzzy Control Strategy Design for the Hydraulic Hybrid Refuse Truck

Gh.H Payeganeh^{1*}, M. Esfahanian², S. Pakdel Bonab³

¹Assistant Professor, Depart. Of Mechanical Eng., Shahid Rejaee Teacher Training University; ²Assist Professor, Depart. Of Mechanical Eng., Isfahan University of Technology ³Master of science, Shahid Rejaee Teacher Training University.

Ghp145@yahoo.com

Abstract

In the present paper, the idea of braking energy regeneration and reusing that energy during acceleration for a refuse truck is comprehended. According to their driving cycle, the refuse trucks have a good potential for braking energy regeneration. On the other hand, hydraulic hybrid is a powertrain with high power density which is appropriate for energy regeneration. In the primary stage of this issue, the hydraulic hybrid propulsion system is designed with intention of regenerating the maximum possible kinetic energy during the refuse truck braking mode. At this stage, a non-fuzzy rule-based control strategy is applied to manage the energy flow in the hybrid powertrain. After that, the powertrain of the Axor 1828 truck and the elements of the hydraulic powertrain are modeled in MATLAB/Simulink. The modeling is performed considering the efficiencies of the powertrain elements. In the last part of the paper, a fuzzy control strategy is designed and modeled to improve the fuel consumption of the truck with hybrid powertrain. In order to see the usefulness of the designed hybrid powertrain, several simulations are organized on the vehicle model in Simulink. The driving cycle for refuse truck in Tehran is used for performing the simulations. The results state indicated that using the hydraulic hybrid powertrain decreased the fuel consumption of the refuse truck by 7 percent. In addition, this amount of reduction was improved by implementing the fuzzy control strategy. The decrease in fuel consumption was due to the regenerating of the braking energy up to 50 percent.

Keywords: regenerative braking, Control Strategy, Modeling, Hydraulic Hybrid, Fuzzy controller

1. Introduction

Transportation is one of the fields with high rate of diesel fuel consumption in Iran which is stemmed from the high weight vehicles like buses and trucks. Unfortunately, the energy efficiency of the vehicles is not a vital problem in Iran due to the low price of the energy. Nowadays, ground transportation is mostly depended to the fossil fuel. This dependence can be decreased by implementing the innovative technologies in vehicle powertrains and increasing their efficiency. The idea of using a secondary powertrain beside the existing Internal Combustion Engine (ICE) in vehicles, which is known as hybrid powertrain is one of the most attracting technologies in recent years. Different variety of the hybrid powertrains are the attention core of several

researchers and also many vehicle production companies all around the world. A hybrid propulsion system consists of two power sources in which one of them has the ability to restore energy. Many of the produced hybrid vehicles are electric hybrids which have a battery pack as their energy storage system. Two main goals of a hybrid vehicle production are ICE management to work in optimal region and regenerating the vehicle kinetic energy during braking. Due to the low power density of the battery, most of the kinetic energy in high weight vehicles cannot be regenerated. So, the hydraulic hybrid systems which have higher power density are used. Figure 1 shows the comparison of the power density and energy density of the different types of energy storage devices. The vehicle which contains hydraulic accumulator as the storage device is named Hydraulic Hybrid Vehicle (HHV). Regarding the nature of the

driving cycle, a refuse truck wastes a large portion of the ICE energy by the mechanical braking system. The fuel consumption of the truck would be decreased if the wasted energy during braking can be regenerated and reused during acceleration. In a hydraulic hybrid powertrain, the accumulator and Pump/Motor (P/M) are used for regeneration of this energy.

Most of the investigations on the HHVs are remained theoretical in laboratories. In one of the early ones, Elder and Otis in 1973 [1], proposed a computer model for a series Hydraulic Hybrid Powertrain (HHP). The model is applicable for different types of cars, vans and buses. The volumetric and mechanical efficiencies of the hydraulic P/M in their models are considered using the Wilson's model [2]. The Wilson's model is a perfect tool for modeling of the losses in hydraulic devices and it has been used in many further researches. The experimental test results for the hydraulic P/M are required to implement this model. It is disadvantageous where the testing equipment is not available. In 1979, Buchwald [3] performed a study on two parallel hydraulic hybrid buses. He implemented the designed HHP on a van to see its effect on fuel consumption reduction of the vehicle. The results showed 25 to 30 percent decrease in fuel consumption. In 1985, a study on modeling of a parallel hydraulic hybrid car was carried out by Tollefson, et al [4]. This investigation proposed a considerable reduction in fuel consumption of the vehicles in urban roads. Also in 1989, Reddy et al [5] organized a study on a parallel hydraulic hybrid bus using a constant displacement P/M. Their purpose

was to investigate the effect of implementation of the variable displacement P/M over the constant displacement in HHPs. Stecki and Matheson in 2005 [6], completed a project on modeling and simulation of the HHP on an armored vehicle. They also designed an appropriate energy management for the proposed hybrid powertrain. The models are generated in MATLAB/Simulink. In 2008 Kim [7] performed a perfect modeling project on different configurations of HHP. His researches on HMMWV were done using MATLAB/Simulink. Finally, Joe-King in 2008 to 2010 [8, 9 and 10] completed several investigations on modeling and simulation of a hydraulic hybrid bus. He generated the hydraulic powertrain model in AMESim and connected it to the whole bus model in Simulink. The efficiencies for the elements of HHP are not considered in Joe-King's Model.

Besides the academic researches, there are some manufactured products for HHP. In 2002, Ford Motors Co. designed and manufactured a parallel HHP for SUV vehicles. Development of the corresponding energy management is presented by Kepner [11]. Also, Bosch Rexroth Co. which is very popular in developing the mobile and industrial hydraulic equipment, proposed an industrial prototype for HHP in 2009. The system is named as Hydraulic Regenerative Braking (HRB). HRB system is implemented on several refuse trucks in Germany. In addition, in 2011 the Altair Co. proposed a commercial prototype of a parallel hydraulic hybrid bus.

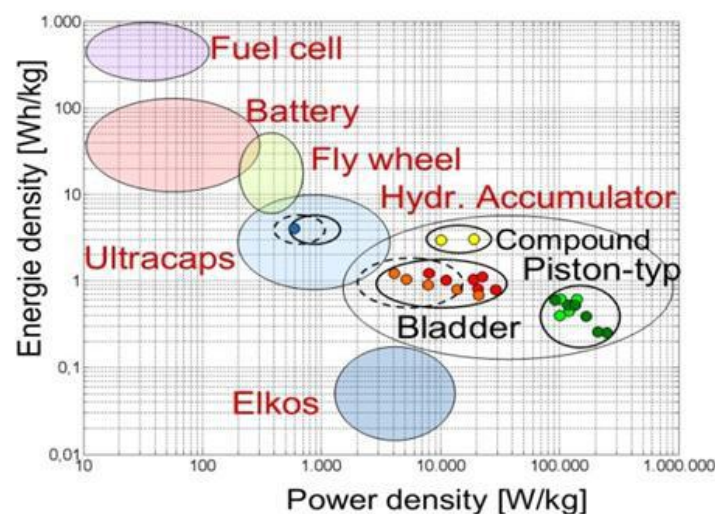

Fig1. Energy and Power density for different types of the energy storage devices

Table 1. Specification of AXOR 1828 Truck

Vehicle specifications	Value
Gross Weight (kg)	5830
Weight considering the passengers (kg)	18000
Wheel radius (m)	0.295
Rolling resistance	0.01
Drag coefficient	0.55
The Efficiency of transmission (%)	0.85
Gear ratio of final drive	3.583
Air density (kg/m ³)	1.202
Engine	MB-OM906LA
Engine Maximum Power	279 HP @ 2300 rpm
Engine Maximum Torque	1100 Nm @ 1250-1500 rpm

Table 2. The Specification of Initial HHP Component

Component	Specifications
ICE	OM906LA Max power : 205 kW Max torque : 1100 Nm
Hydraulic P/M	A4VSO Max power : 131 kW Max torque : 696 Nm Maximum displacement : 125 cc/rev
Accumulators	1 bladder type Maximum operating pressure : 350 bar Nominal Volume : 50 liters

In the present paper, the HHP is designed for a refuse truck by intention of absorbing the maximum braking energy. When the specifications of the powertrain elements are determined, a model for the truck and the hydraulic powertrain is generated. The model is proposed in MATLAB/Simulink. The losses of all elements in hybrid powertrain are considered in the model. In addition, a fuzzy control strategy is proposed for torque management between the ICE and P/M during acceleration. At the end, the simulation results are presented. In order to increase the validation of the results, the refuse truck driving cycle in Tehran is used for simulations.

2. Designing of Propulsion Hydraulic Hybrid System

Here, Axor 1828 refuse truck is chosen as the based vehicle and the elements of HHP is designed according to the specifications of this vehicle. The specification of Axor 1828 truck is presented in Table I.

One of the most important design assumptions is to have minimum changes in the chassis structure of the truck. By using the series HHP, a lot of modification is needed for arrangement of the powertrain elements on vehicle chassis. As the result, parallel configuration which is accompanied by lower

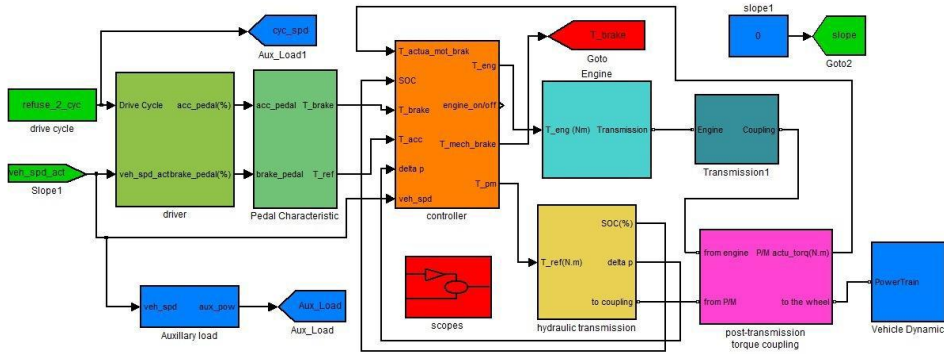

Fig2. The model for powertrain of the hydraulic hybrid refuse truck

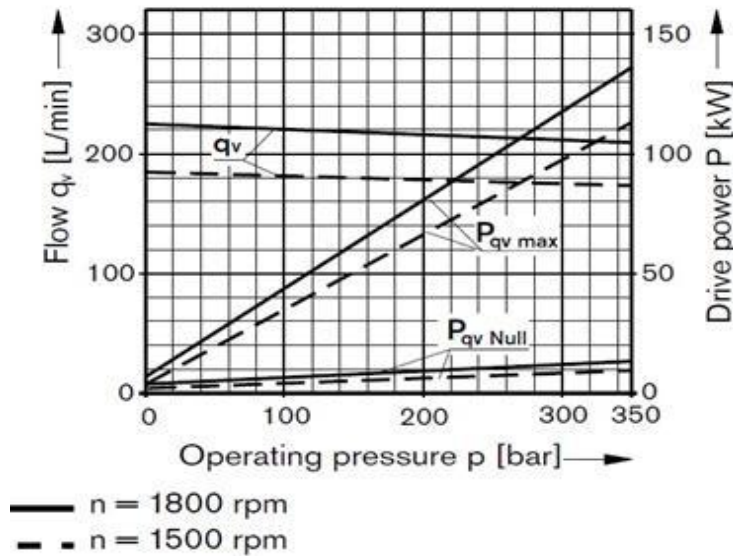

Fig3. The Map for determining the efficiencies of hydraulic P/M

modifications in vehicle chassis is considered for implementation of the HHP. In addition, downsizing the ICE is not possible due to the low energy density of the accumulator. Using the engine with lower maximum power decreases the performance of the truck in continuous driving conditions, like gradeability. So, the default ICE of the conventional AXOR 1828 is used in designing of the HHP. The specification of the engine is presented in TABLE I.

In order to size the appropriate accumulator, the amount of kinetic energy available for regeneration during braking from 30 km/h to rest is computed. Choosing this speed range for designing the accumulator is based on the refuse truck driving cycle [14]. Accumulator sizing includes determination of its nominal volume and also required numbers. By implementing the following equations.

$$E_{Rec} = (E_{Kin} - E_R - E_A)\eta_D$$

$$E_{Acc} = E_{Rec} \times \eta_V \times \eta_{mh} \times \eta_{coup} \tag{1, 2}$$

for the mentioned speed range, the generable braking energy is 470 kJ. Also, the available energy for storing in the accumulator is 400 kJ considering the mechanical and volumetric efficiencies of the hydraulic P/M and the power losses in torque coupling gearbox. For storing this amount of energy, an accumulator with nominal volume of 50 liters and maximum working pressure of 350 bars is required.

For making decision about the appropriate hydraulic P/M, the required negative torque to brake the truck well and regenerate maximum kinetic energy is determined. Then, by considering the final drive ratio and choosing the best ratio for torque coupling gearbox, the required value for maximum

displacement of the P/M is derived using the following equation.

$$V_g \times i_{coup} = 20 \times \pi \times M_{coup} \times \eta_{coup} \times \eta_{mh} / (\Delta P) \quad (3)$$

By choosing the ratio of the torque coupling gearbox equals to 2.5, the maximum required P/M displacement is 125 cc/rev. regarding the constraints for equipment supplying, the designed accumulator and P/M is chosen among the Bosch Rexroth Co. productions. The specifications for the main elements of the designed HHP are presented in TABLE II. The entire procedure of designing the HHP for AXOR 1828 refuse truck is presented in a paper by the authors [14].

3. Modeling of Parallel Hydraulic Hybrid Powertrain

As mentioned above, the parallel configuration is chosen for implementing the hydraulic hybrid powertrain. Here, a model is proposed for this powertrain. In the feed-forward model of parallel HHP, the driver block creates appropriate command signal according to the difference between the drive cycle and the actual vehicle speeds. This signal is sent to the Hybrid Central Control (HCC) block. The HCC block is the heart of the hybrid model and computes the torques of each power sources so as to satisfy the driver demand. The performance of this block is based on the designed control strategy. The output signals of the HCC block is sent to the ICE and hydraulic P/M blocks. These two blocks generate the demanding torques. Finally, both output torques are coupled in torque coupling and final signal is sent to the vehicle dynamic block. The equations for dynamics of vehicle considering the resistance forces are modeled in the vehicle dynamic block. In braking mode, the P/M operates as pump and charges the accumulator under the 30 km/h. The difference between the demand braking torque and the negative P/M torque is compensated by the mechanical brakes of the truck. The regenerative braking is deactivated above the 30 km/h and the entire braking torque is generated by mechanical brakes. The operation range for the regenerative braking is determined regards to the refuse truck driving cycle [14]. The generated model for the hydraulic hybrid refuse truck in MATALB/Simulink is presented in Figure 2.

A. Hydraulic P/M Model

The main consideration in modeling of components of a powertrain is their efficiencies. In 1950, Wilson proposed a model that can determine the hydraulic machines' efficiencies with the use of

volumetric and torque losses. Some experiments should be conducted in order to use the Wilson's model which is a constraint for use of it. Using the efficiency map is the alternative choice. If we use the efficiency map, there is not any constraint to model the hydraulic machine.

There is an efficiency map for hydraulic P/M in the manufacturer's catalogue (Figure 3). The volumetric and total efficiencies of hydraulic P/M in the pump mode operation are determined by use of this map. The efficiency map is implemented by use of look-up tables in Simulink.

The following equations

$$\eta_v = \frac{q_v \times 1000}{v_g \times n} \quad (4)$$

$$\eta_t = \frac{q_v \times \Delta p}{p_{max} \times 600}$$

$$\eta_{mh} = \frac{\eta_t}{\eta_v} \quad (5, 6)$$

have been used to determine the efficiencies of the hydraulic P/M. In these equations p_{max} and q_v are determined by the map of Figure 3. It should be noted that these efficiencies are for the pump mode operation of the hydraulic P/M. However, the above efficiencies can be used for motor mode operation with high accuracy. This claim would be true according to comparison between the efficiencies map of available hydraulic axial piston P/M's in their both pump and motor operation.

In addition to hydraulic P/M efficiency, we need to model its torque generation using the following equations:

$$M_{pump} = \frac{v_g \times \Delta p}{20 \times \pi \times \eta_{mh}}$$

$$M_{motor} = \frac{v_g \times \Delta p \times \eta_{mh}}{20 \times \pi} \quad (7, 8)$$

It should be noted that the torque which the hydraulic P/M can be produced is dependent on the pressure difference in the hydraulic circuit and also the P/M displacement. There is a separate block in the P/M model that computes this torque.

For controlling the hydraulic P/M torque, the only controllable parameter is the P/M displacement, g , as seen in equation (7). Therefore, an appropriate control signal should be sent to the P/M block in order to achieve the desired torque at the P/M shaft. The control signal is generated by a PID controller according to the difference between the desired P/M torque and its real one. The controller model for P/M displacement is shown in Figure 4.

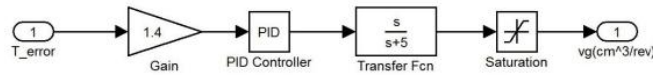

Fig4. Model for controller of hydraulic P/M Displacement

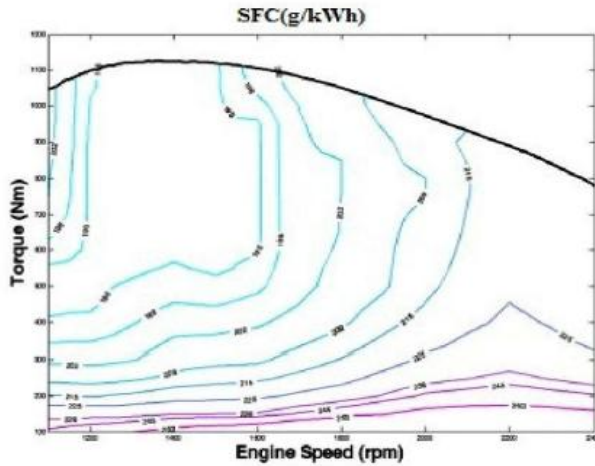

Fig5. The BSFC map of OM906LA engine

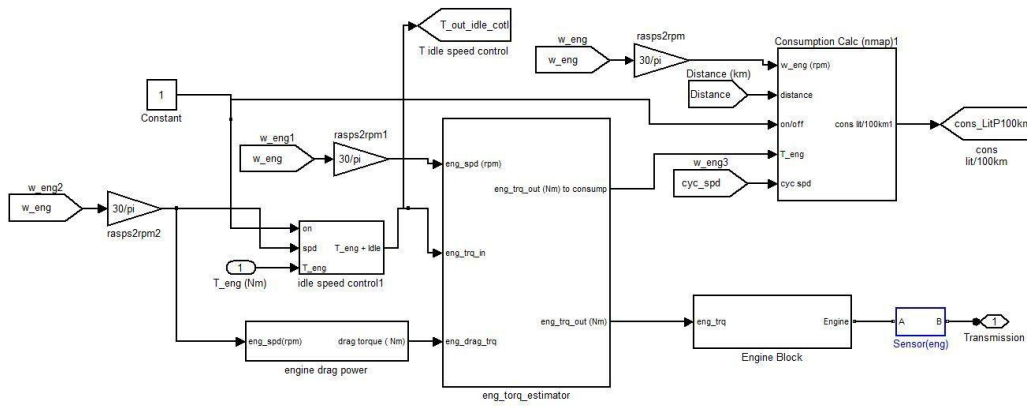

Fig6. The ICE Model

B. ICE model

The efficiency of ICE should be considered in order to model the engine accurately. The efficiency of an ICE can be represented by BSFC map (Figure 5). Actually, the fuel consumption of the whole vehicle is computed regarding this map.

There is a look-up table in the model of ICE that computes the BSFC of engine in every speed and torque. Thus, fuel consumption of ICE can be

computed by using this look-up table. Also, there is a block in the ICE model that determines the torque output of the engine. The provided engine torque is constrained by its upper band. The model for ICE is shown in Figure 6.

C. Accumulator Model

An accumulator in hydraulic hybrid drivetrain plays the role of battery in an electric hybrid. Bladder accumulators store energy in form of pressurized gas.

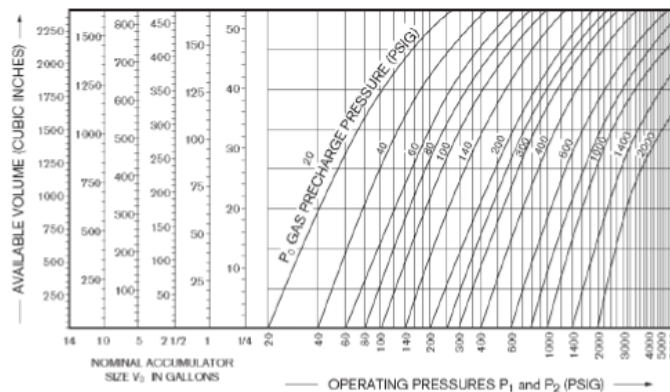

Fig7. Map of Volume-Pressure for Bladder Type Accumulator

The thermodynamic process of the gas behavior should be specified in order to model the accumulator. In reality, the process that gas acts on happens so fast that there is no heat transfer between gas and its environment. Speed of the process depends strongly on the frequency of torque command signal which is sent from HCC block. This frequency is normally very high for most hybrid control strategies. As a result the gas process is assumed to be adiabatic. The corresponding equation for gas behavior is as follows:

$$p_0 \times v_0^n = p_1 \times v_1^n = p_2 \times v_2^n = p_x \times v_x^n \quad (9)$$

In the above equation, the initial pressure, the minimum and the maximum pressures of accumulator gas are shown by p_0 , p_1 and p_2 , respectively. Also v_0 , v_1 and v_2 represent the volumes of corresponding situations. The values of pressure and volume of gas in an unknown situation is shown by p_x and v_x . Also, n represents the gas specific heat ratio (for N_2 is 1.4).

In addition to the gas process, the values of maximum and minimum operating pressures of the hydraulic system as well as the pre-charge pressure of the accumulator should be determined. The maximum operating pressure of the hydraulic P/M is 350 bars and pre-charge pressure of accumulator is 180 bars. Using these values and following equation:

$$p_{min} = p_{pre}/0.9 \quad (10)$$

The minimum operating pressure of the hydraulic circuit is equal to 200 bars.

A look-up table has been used in order to compute the accumulator block outputs. This look-up table is based on the provided map in the accumulator catalogue. The map, Figure 7, determines the

available volume of fluid that can be stored in the accumulator for different pressures. Actually, this map considers the efficiency of accumulator operation. The most important output variable of the accumulator block is its State-of-Charge (SOC). SOC represents the ratio of fluid volume to its maximum by following equation:

$$SOC(\%) = \frac{v_x}{v_{max}} \times 100 \quad (11)$$

The maximum fluid volume in the accumulator corresponds to the maximum gas pressure situation.

D. Transmission Model

The transmission of the Parallel HHP has a post-transmission torque coupling. This coupling contains two spur gears on the shafts of two power sources. Each of the power sources has its own gearbox. According to the controllable nature of hydraulic P/M, it has only a one-speed gearbox. But a multi-ratio gearbox is used for improving the output torque of ICE. To disconnect the P/M from the wheels, a clutch is used which operates based on the command signal received from the HCC block.

E. Auxiliary Power Unit Model

Operation of the Auxiliary Power Unit (APU) for a refuse truck can be categorized in two portions. The first one includes general demanding power of the vehicle including cooling system, power steering system, lubrication system and electric power supply system. Trash Collection and compaction system is the second portion of a refuse truck APU which is named as loading mechanism. The required power of

the two portions of the APU is supplied by the ICE. The first part of APU operation is activated in entire driving cycle. But, the loading mechanism is activated when the vehicle stops. The power demand of the loading mechanism is different for refuse trucks of each city around the world. Based on the precise observation of the AXOR 1828 refuse truck operation in Tehran [16], it is determined that there are two procedures for loading mechanism in Tehran refuse trucks. In both procedures, a handle operated by the driver is applied to activate the loading mechanism. In the first procedure, the engine rotation velocity is defined according to the driver demand torque (acceleration pedal) and the engine dynamics. But in the second procedure, the engine rotation is set by an external regulator and is independent of the acceleration pedal. According to the automatic nature of the second procedure, this is used in modeling of the refuse truck loading mechanism.

In addition to the ICE rotation velocity, the duration of the loading process is vital in modeling of the refuse truck APU. The time schedule of loading mechanism in the Tehran refuse truck is:

- 15 seconds for preparing the trash basket for loading
- 5 seconds for raising the trash basket
- 2.5 seconds for putting down the basket
- 20 seconds for compaction of the trash

The above time schedule is derived by several observation of the refuse truck operation. Actually when the vehicle stops, it takes the driver 15 seconds to turn the handle on. The whole duration time for operating of the loading mechanism is between 25 to 40 seconds. This duration depends on ICE rotation speed and hydraulic pump displacement. The above time schedule for loading mechanism is considered in model of the refuse truck APU.

4. Hybrid Central Control Unit

Energy management or control strategy is an indispensable unit in a hybrid vehicle. All of the expected outcomes from a hybrid powertrain would not be satisfied, if the energy management doesn't work properly. In this paper, a non-fuzzy rule-based control strategy is proposed and modeled for the hydraulic hybrid refuse truck. This control strategy is applied before on a parallel hydraulic hybrid bus [15] with a little difference. In that control strategy, the ICE power is used for charging the accumulators sometimes in the driving cycle. But here, this possibility is eliminated aims to recover more kinetic energy during the vehicle braking mode.

The control strategy for the Parallel HHP has been implemented in HCC block. The driver demanding torque, vehicle speed and the accumulators SOC are input variables for the HCC block. In this block, the desired torque of two power sources is determined according to the control strategy and the input variables. The control strategy is as follow:

First mode. The truck is in acceleration mode, driver demanding torque is below T_0 , vehicle speed is below V_0 and the SOC is above the minimum allowable value. The demanding torque from driver is provided by hydraulic P/M alone and the ICE is off. T_0 is 500 Nm and V_0 is 5 km/h in the control strategy.

Second mode. The truck is in acceleration mode, driver demanding torque is above T_0 , vehicle speed is above V_0 and the SOC is above the minimum allowable value. In this mode, the ICE turns on and operates as the main power source of the Parallel HHP. Also, the ICE would be helped by the hydraulic P/M in situation that the driver demanding torque is above the maximum torque generated by the engine. Accumulator charging is not considered in this mode.

Third mode. The truck is in acceleration mode and the SOC of accumulator is not above the minimum allowable value. In this mode the ICE is the only power source in Parallel HHP. Accumulator charging is not considered in this mode, too.

Fourth mode. The truck is in braking mode. In this mode, the hydraulic P/M is working as a pump and generates the main braking torque for the truck (Regenerative Braking). The mechanical braking system of the truck would be used if the generated torque by the hydraulic P/M is not sufficient.

In the proposed control strategy, the values of desired torque of both power sources have been determined in such a way that the command signal frequencies are not high. The reliability of model would be reduced when high frequencies exist in these signals. The implementation of this control strategy has been performed by a state-flow block in Simulink.

5. Designing of Fuzzy Control Strategy

The control rules for energy management of a hybrid powertrain can be stated by a Fuzzy Inference System (FIS). The designed FIS for hybrid energy management is named as a fuzzy control strategy. Here, a fuzzy control strategy is designed for the hydraulic hybrid refuse truck. The designed fuzzy control strategy includes 4 sets of membership functions. These sets are correspond to driver demanding torque, vehicle speed and accumulator SOC as the input parameters and P/M torque

command as the output variable. In each set, numbers of fuzzy membership functions are defined according to the required control rules. It is apparent that the control rules should be designed in a way to achieve the least fuel consumption. The membership functions corresponding to each parameter are presented in Figure 8.

The main part of the fuzzy control strategy design procedure is definition of the fuzzy rules. The rules are generated based on the conditions on which the ICE operates efficiently and the most amount of kinetic energy can be regenerated. In addition, the logic behind the operation of the similar hybrid vehicles is considered in design procedure. In this paper, the electric hybrid bus prototyped by the

Vehicle, Fuel and Environment Research Institute (VFERI) of University of Tehran and the hydraulic hybrid refuse truck manufactured by Bosch Rexroth Co. are the vehicles which their energy management is studied to achieve more appropriate control strategy for the proposed hydraulic hybrid refuse truck. Finally, the rule used in the fuzzy control strategy is presented in Table 3. The designed fuzzy control strategy is implemented in the model of HHP by MATLAB Fuzzy Logic toolbox. Using this control strategy the P/M torque command is generated. Then the ICE and mechanical brake torque commands are derived by subtracting the P/M torque from the driver demand.

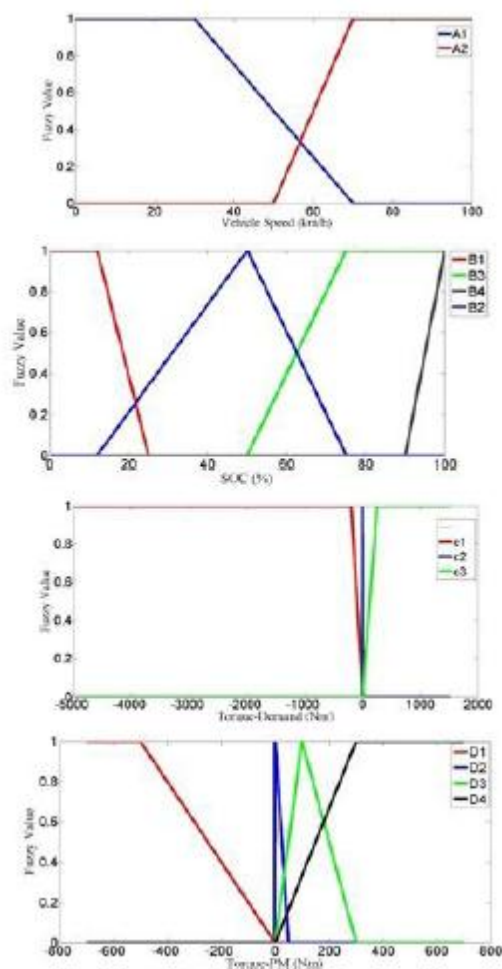

Fig8. The membership functions used in fuzzy control strategy

Table. 3 Rules of Fuzzy Control Strategy

No.	Rule
1	If (SOC is B3) and (TRQ-DEM is C3) then (T-PM is D4)
2	If (SOC is B2) and (TRQ-DEM is C3) then (T-PM is D3)
3	If (SOC is B1) and (TRQ-DEM is C3) then (T-PM is D2)
4	If (TRQ-DEM is C2) then (T-PM is D2)
5	If (VEH-SPD is A1) and (SOC is not B4) and (TRQ-DEM is C1) then (T-PM is D1)
6	If (VEH-SPD is A2) and (TRQ-DEM is C1) then (T-PM is D2)
7	If (VEH-SPD is A1) and (SOC is B4) and (TRQ-DEM is C1) then (T-PM is D2)

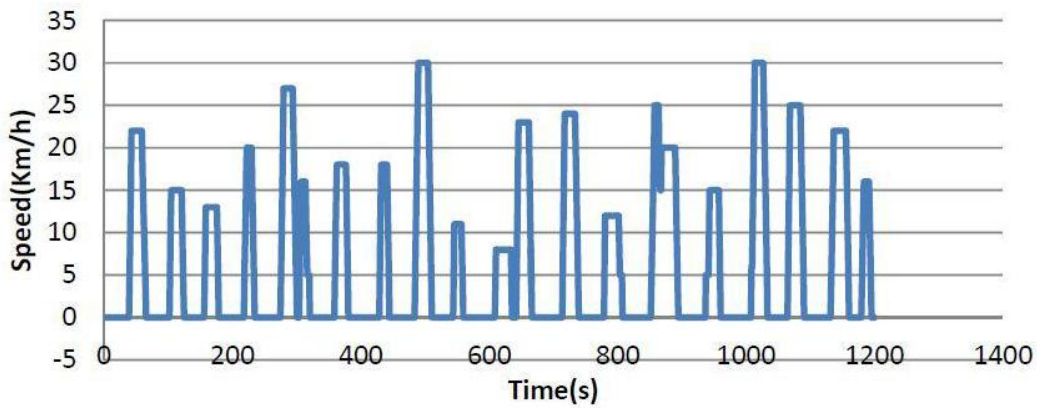

Fig9.Refuse Truck driving cycle [14]

Table 4. The Portions of Kinetic Energy during the Refuse Truck Braking

Energy label	Value (kJ)	Portion (%)
Total Kinetic Energy during braking	6557.8	100
Energy loss due to the wheel resistance force	192.39	2.93
Energy loss due to the drag force	4.098	0.07
Regenerable Energy during braking	6361.3	97

Table 5 .Comparison of Fuel Consumption in Conventional and Hybrid Refuse Trucks

Vehicle	Fuel Consumption (lit/100 km)	Fuel Consumption reduction (%)	Driving Fuel Consumption (lit/100 km)	Driving Fuel Consumption reduction (%)
Conventional Refuse Truck	84.3	-	54.53	-
Hydraulic Hybrid Refuse Truck – Non-Fuzzy control Strategy	78.39	7.01	47.12	13.6
Hydraulic Hybrid Refuse Truck –Fuzzy control Strategy	75.52	10.42	45.11	17.27

6. Simulation Results

After designing and modeling stages, the AXOR 1828 model has been simulated in the refuse truck

driving cycle (Figure 9). The simulations are performed to assess the utility of powertrain hybridization on a refuse truck. In addition, the performance of the fuzzy control strategy for reduction of fuel consumption is evaluated. The simulations are performed in Simulink with 0.01 time

step. Also, the initial SOC of the accumulator is 70 percent.

In order to have sense about the potential of the kinetic energy regeneration in a refuse truck, the total amount of kinetic energy during braking, the braking energy due to the drag and wheel resistance forces and 12

Also the generable braking energy are presented in Table 4. . As can be seen, most of the kinetic energy during braking can be regenerated. The amount of regenerated energy is depended on accumulator and P/M sizes, their efficiencies and also the control strategy.

The values for fuel consumption of the conventional truck and hydraulic hybrid truck using non-fuzzy and fuzzy control strategies are presented in Table 5 .A large portion of the trucks fuel consumption is due to the APU operation. 4th and 5th

columns of the table show the fuel consumption of the trucks just for driving. As can be seen, implementing the HHP decreases the fuel consumption of the conventional refuse truck by 7 percent. The reduction is improved 3.4 percent by using the fuzzy control strategy.

In Figure 10 and Figure 11, the changes in amount of driving energy, regenerated energy and mechanical braking energy for the hybrid truck in an entire driving cycle are shown with and without fuzzy control strategies. As can be seen the portion of regenerated energy in total generable energy of the truck is higher for the hybrid powertrain using the fuzzy control strategy. 61.4 percent of the generable energy is recovered by implementing the fuzzy control strategy on the HHP. The value of this parameter is 50 percent using the non-fuzzy control strategy.

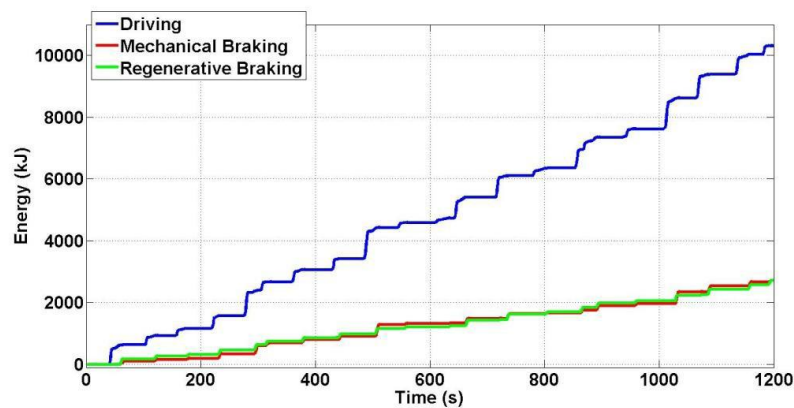

Fig10. Changes in driving, mechanical braking and regenerative braking energies using non-fuzzy control strategy

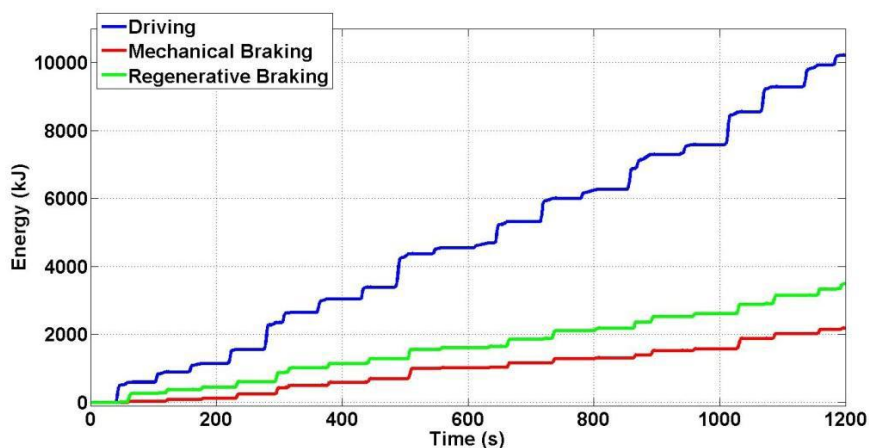

Fig11. Changes in driving, mechanical braking and regenerative braking energies using non-fuzzy control strategy

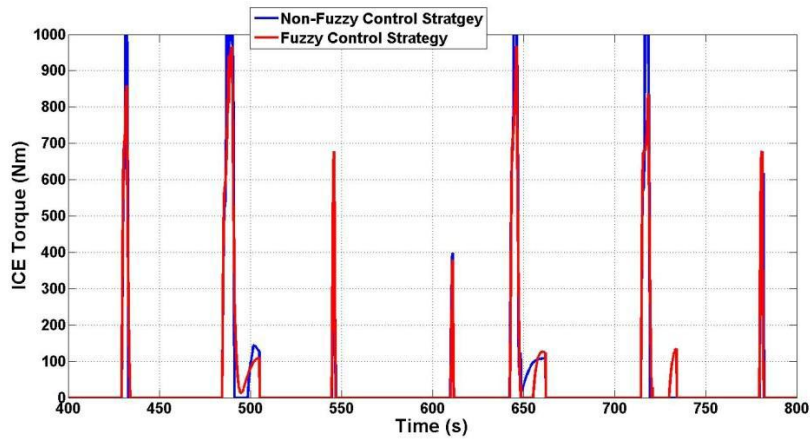

Fig12. Comparison of ICE command torque using fuzzy and non-fuzzy control strategy

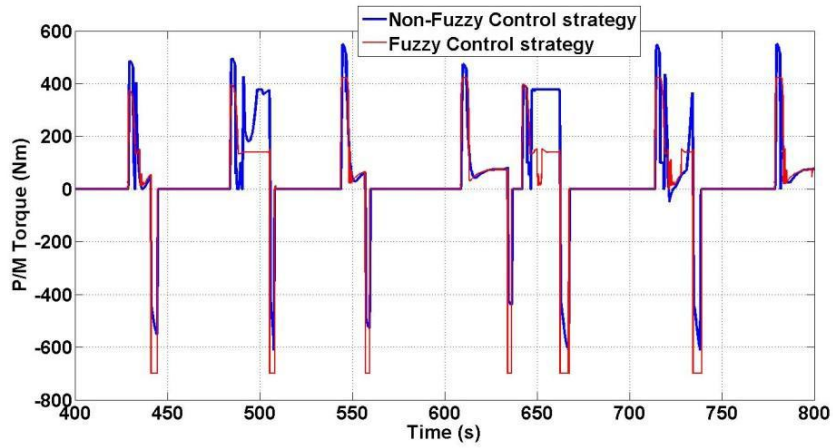

Fig13. Comparison of P/M command torque using fuzzy and non-fuzzy control strategy

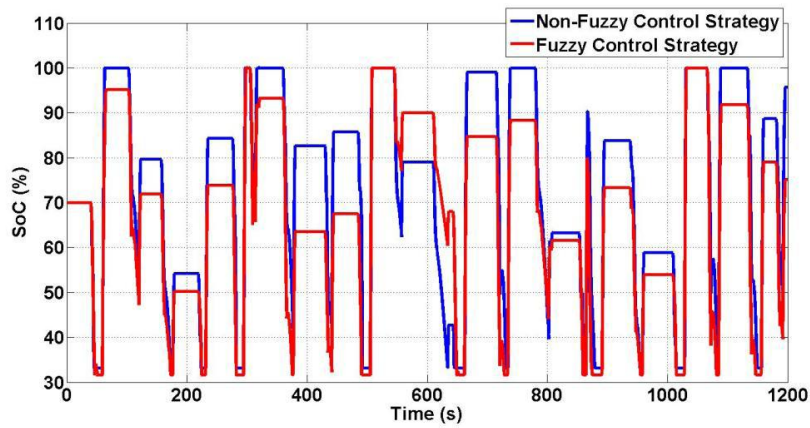

Fig14. Comparison of SOC changes using fuzzy and non-fuzzy control strategy

The command signals for ICE and P/M in the HHP using two proposed control strategies are shown in Figure 12 and Figure 13. According to these plots, it is understood that energy recovery is performed more using the fuzzy control strategy. Also, the number of times which the ICE torque command reaches its maximum value (1100 Nm) is more using the non-fuzzy control strategy. This aims to higher fuel consumption.

Finally, the changes in SOC of the accumulator during the entire driving cycle are shown in Figure 14. It is apparent that the fuzzy control strategy tries to hold the SOC at low levels to preserve the accumulator capacity for energy regeneration.

7. Conclusion

In this paper, a parallel hydraulic hybrid powertrain for a refuse truck has been designed and modeled. The powertrain consists of a diesel Internal Combustion Engine as the primary and a hydraulic Pump/Motor as the secondary power sources. Also, the hydraulic accumulators have been used as the energy storage components. The two power sources have been connected to the driven shaft through a post-transmission torque coupling. The modeling of hybrid powertrain components has been performed considering their efficiencies which are modeled by use of look-up tables. Also, the auxiliary power unit of the refuse truck is modeled based on real observations. The feed forward model for the hybrid powertrain has been created in MATLAB/Simulink. In addition, a fuzzy control strategy is designed to improve the usefulness of the powertrain hybridization. Some simulations are performed to see the effects of hydraulic hybrid powertrain on reducing the fuel consumption of the refuse truck. Also, the performance of the designed fuzzy control strategy is compared with those of a non-fuzzy one. The simulation results show that large amount of kinetic

Energy is generable during braking mode of the refuse truck. Moreover, more than 50 percent of this energy would be regenerated by implementing the hydraulic hybrid powertrain. Comparison with the conventional model shows at least 7 percent reduction of fuel consumption for hydraulic hybrid technology can be achieved. This value is improved to 10 percent by using the fuzzy control strategy.

Acknowledgment

This work was performed in cooperation with Vehicle, Fuel and Environment Research Institute (VFERI) of University of Tehran.

References.

- [1] Elder, F. T., and D. R. Otis. 1973. Simulation of a hydraulic hybrid vehicle powertrain, ASME 73-ICT-50.
- [2] Wilson, W. E. 1950. Positive-displacement pumps and fluid motors. Sir Isaac Pitman and Sons, LTD, London.
- [3] Buchwald, P., G. Christensen, H. Larsen, and P. S. Pedersen. 1979. Improvement of city bus fuel economy using a hydraulic hybrid propulsion system – A theoretical and experimental study. SAE paper 790305.
- [4] Tollefson, S., Beachley, N.H. and Fronczak, F.J., Studies of an accumulator energy-storage automobile design with a single pump/motor unit, SAE paper 851677, 1985.
- [5] Reddy, S. C., and G. V. N. Rayudu. 1989. Design of a regenerative braking system for city buses. SAE paper 892529.
- [6] Stecki, J., and P. Matheson. 2005. Advances in automotive hydraulic hybrid drives. Proceedings of the 6th JFPS International Symposium on Fluid Power. Tsukuba, Japan.
- [7] Young Jae Kim, Integrated modeling and hardware-in-the-loop study for systematic evaluation of hydraulic hybrid propulsion options, A dissertation submitted in partial fulfillment of the requirements for the degree of Doctor of Philosophy (Mechanical Engineering) in The University of Michigan, 2008.
- [8] YAN Ye-cui, LIU Guo-qing and CHEN Jie, –Parameters Design Strategies of a Parallel Hydraulic Hybrid Bus||, IEEE Vehicle Power and Propulsion Conference (VPPC), September 3-5, 2008, Harbin, China.
- [9] Guo-Qing Liu, Ye-Cui Yan, Jie Chen, Tian-Ming Na, –Simulation and Experimental Validation Study on the Drive Performance of a New Hydraulic Power Assist System||, Intelligent Vehicles Symposium, 2009 IEEE.
- [10] Y. YAN, G. LIU and J. CHEN, –Integrated Modeling and Optimization of a Parallel Hydraulic Hybrid Bus||, International Journal of Automotive Technology, Vol. 11, No. 1, pp. 97–104 (2010).
- [11] Kepner, R.P.,Hydraulic –power assist demonstration of hydraulic hybrid vehicle regenerative braking in a road vehicle application||. SAE Paper 2002-01-3128, 2002.
- [12] Axor-R Catalog. Tongwell, Milton Keynes, MK15 8BA. : Mercedes Benz UK Ltd., 2008.

- [13] Naghizadeh, Mojtaba, 2006. —Driving Cycle Development for Simulation of vehicle Fuel Consumption|| MS Thesis, Iran University of Science & Technology.
- [14] Pakdel Bonab, S., Payegane, Gh. and Esfahanian, M. 2013, —Extracting the driving cycle and hydraulic hybrid powertrain designing for a refuse truck,|| under review.
- [15] Esfahanian V., Safaei A. and et. al, —Design and Modeling of a Parallel Hydraulic Hybrid Bus,|| International Conference on Applications and Design in Mechanical Engineering (ICADME 2012).
- [16] Pakdel Bonab, S., —Design and Analyze of Hydraulic Hybrid Powertrain for a Refuse Truck,|| the dissertation in partial fulfillment of degree of master of science in Mechanical Engineering, Shahid Rajaei Teacher training University, 2012.