

# Power Distribution Development and Optimization of Hybrid Energy Storage System

M. Masih-Tehrani<sup>1</sup>, M.R. Hairi-Yazdi<sup>2</sup>, V.Esfahanian<sup>3</sup>

1 Assistant Professor, School of Automotive Engineering, Iran University of Science and Technology 2 Associate Professor, School of Mechanical Engineering, College of Engineering, University of Tehran 3 Professor, School of Mechanical Engineering, College of Engineering, University of Tehran And Vehicle, Fuel and Environment Research Institute, University of Tehran

masih@iust.ac.ir

## Abstract

In this paper, the development and optimization of Power Distribution Control Strategy (PDCS) have been performed for a Hybrid Energy Storage Systems (HESS) of a Series Hybrid Electric Bus (SHEB). A common PDCS is based on the use of Ultra-Capacitor (UC) pack. A new simple PDCS is developed as a battery based one. For the battery based PDCS, four parameters are introduced for tuning the PDCS performance. The Design of Experiment (DoE) method is utilized to optimize the parameters of the battery based PDCS for the driving cycles and the vehicle controllers. The results show the optimized battery based PDCS performance for some cases are better than the UC based PDCS performance. Vice versa, for some cases the performance of the UC based PDCS is better than the battery based PDCS. Finally, the costs rising from the HESS (about 66%) is reasonable when considering the over double increase in the battery life-time when using an appropriate PDCS.

*Keywords:* Power Distribution Control Strategy, Hybrid Energy storage system, Series Hybrid electric bus, Design of Experiment

## 1. Introduction

The Energy Storage System (ESS) is the main drawback in commercialization of different kinds of electric and hybrid electric vehicles. Recently, a rapid evolution of EV has begun, which is driven largely by the development of battery of large storage capacity and reduced cost [1].

The Series Hybrid Electric Bus (SHEB) is an environmentally-friendly vehicle with an acceptable cost and a short-term market penetration [2] for utilization in crowded and polluted cities. The SHEB has been designed and fabricated in Vehicle, Fuel and Environment Research Institute (VFERI), University of Tehran, Iran [3]. The SHEB is a SHEV in which the all of its propulsion energy is produced by the electric-machine. Accordingly, the SHEB has high energy and power demands for propulsion. In VFERI, a dynamic feed-forward model of the series hybrid

electric city bus has been developed using MATLAB/Simulink [4].

The most common ESS of EVs is battery. Batteries are preferred in the market due to their low cost and portability [5]. Batteries have high energy and low power specifications for use in EVs (peak-to-average power ratios are between 0.5 to 2 [6]). As battery costs continue to decrease, EVs will become more attractive for a larger pool of customers. However, the life-time for battery advances is uncertain [7]. Another candidate for ESS is Ultra-Capacitor (UC). UCs have good life cycle, low energy and high power specifications (peak-to-average power ratios are between 10 to 12 [6]). Also, the cost of UCs has been falling significantly during the last decade [8]. The complementary specifications of batteries and UCs can be beneficially combined to make a new ESS of EVs that shows high performance with low weight and suitable battery life at a reasonable cost [9]. In recent years, some designs have been proposed to implement this idea for

developing a Hybrid Energy Storage System (HESS) with high energy and high power specifications. The main objective of coupling batteries and UCs is to reduce the current stress in the batteries in order to decrease its size and cost and to improve its life-time [10]. The Power Distribution Control Strategy (PDCS) of a HESS has a great effect on its behavior [11]. The common PDCS is the UC based PDCS. This PDCS commands to the UC to supply the demand power of the vehicle up to the UC limits and then the battery generates the excess demand power of the vehicle [12]. In addition, some complicated PDCS are introduced in the literature of the HESS, such as the UC state of charge control ([13],[14]) and another based on an optimization model using neural networks [15]. In this paper, a simple UC based PDCS is implemented for the SHEB. In addition, a new simple PDCS is established as a battery based one. The main idea of the battery based PDCS is to use the battery as the prior ESS to provide the demand power of the vehicle. When the battery power is not enough, the battery based PDCS commands the DC/DC converter to utilize the UC pack to provide the excess demand power. In addition, the PDCS charges the UC in the normal working modes, in order to prepare it for the next high power situation. Also, four parameters are introduced for tuning the PDCS performance. The Design of Experiment (DoE) method is utilized to optimize the parameters of the battery based PDCS.

## 2. Powertrain Structure

A series hybrid electric bus has been designed and fabricated in Vehicle, Fuel, and Environment Research Institute (VFERI) of University of Tehran,

Iran. The base vehicle of this hybrid electric bus is the O457 city bus. The hybrid powertrain configuration of the O457 SHEB has been presented in Fig1

As shown in Fig1, the SHEB powertrain is the series configuration. The propulsion system has been consisted of two traction motors, which are coupled using a coupling gearbox. The existence of two traction motors instead of one, upgrades the flexibility of hybrid vehicle controller to turn off one of them during often normal modes of driving situations. The 3-phases traction motors can propel and brake the SHEB during acceleration and deceleration. The regenerative braking energy can be stored in the batteries. Every 3-phases traction motors have been driven by an inverter. The inverters are the interfaces between high voltage DC bus and the 3-phases traction motors. The high voltage bus of the SHEB has been connected to the generator and the batteries. The 3-phases generator has been connected to the high voltage bus using an inverter. The generator, also, has been coupled to the output shaft of the Internal Combustion Engine (ICE) by a gearbox to keep the consistency of their speeds. The ICE-generator can provide average power demands of the SHEB (power follower strategy), or only charge the batteries when they have been depleted (thermostat strategy). These working strategies of the ICE-generator have been managed by the hybrid vehicle controller.

One of the well-known rules for series hybrid powertrain design is that the ICE-generator provides the average part and the batteries provide the fluctuation parts of the vehicle power demands. Attending to which strategy (the power follower or the thermostat) has been selected by the hybrid vehicle controller, the power and the energy requirements of the batteries have been determined.

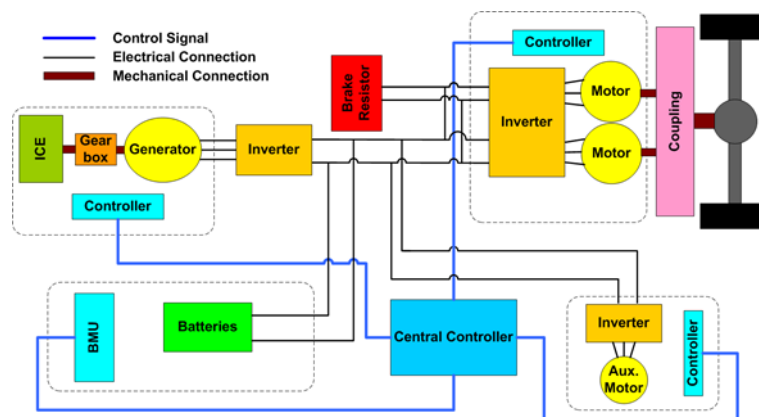

Fig1. The hybrid powertrain configuration of the O457 hybrid electric bus [17]

**Table 1:** Main Characteristics of Vehicle

• Characteristic	• Value
Mass	18000 kg
Rolling resistance coefficient	0.01
Drag coefficient	0.79
Wind speed coefficient	0.2
Frontal area	6.75 m <sup>2</sup>
Tire radius	0.508 m

**Table 2:** Main specifications of the SHEB powertrain

• Component	• Specification
High voltage bus	650 V
Traction Motors	85 kW 220 Nm (Peak 530 Nm) 142 A (Peak 300 A)
ICE-generator	130 kW 200 A
Batteries	168 Lithium polymer cells 3.7 V (Maximum 4.2 V) 40 Ah (24.9 kWh) Continuous Discharge: 200 A Peak Discharge: 400 A Charge: 80 A

**Table3.** UC module characteristics

Capacitance (F)	Peak Current (A)/ Power (kW) (1 second)	Maximum Continuous Current (A)/ Power (kW)	Nominal Voltage (v)	Energy (Wh)	Weight (kg)
165	4000/ 194.4	150/ 7.3	48.6	54	16.5

The main characteristics of the SHEB are listed in 0 and Main specifications of the SHEB powertrain are listed in 0.

In 0, the UC module characteristics are listed. In comparison with the utilized Lithium battery, the power specification of UC (14.4 kW/kg) is very greater than of battery (1.53 kW/kg) and the energy specification of UC (4.00 Wh/kg) is very smaller than

of battery (134.55 Wh/kg). as a design advice, the power capability of UC is considered the maximum continuous power (because of the very short-term nature of UC peak power), and its energy capacity is assumed 75% maximum energy, because of input minimum voltage limitation of DC/DC converter [18].

The power discharge profile of UC is shown in Fig2.

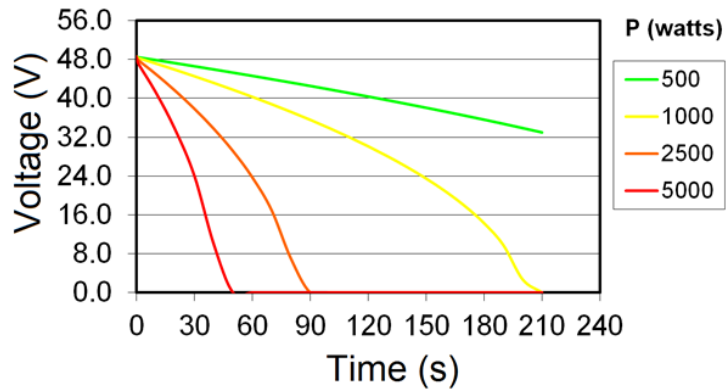

Fig2. Power discharge profile of UC

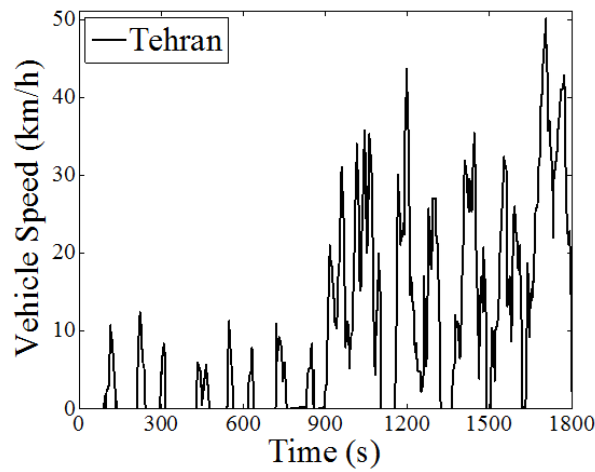

Fig3. Tehran city bus driving cycle

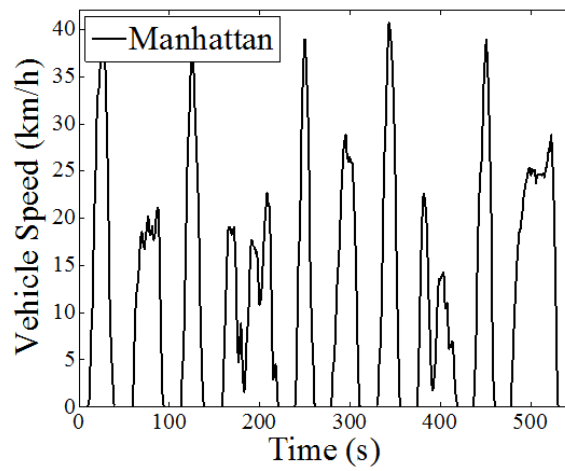

Fig4. Manhattan city bus driving cycle

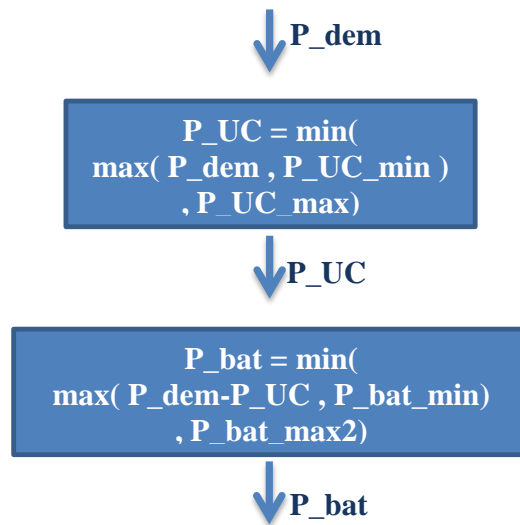

Fig5. UC based PDCS flowchart

In this paper, 14 UC modules in series configuration are selected for using in the HESS of the SHEB. The voltage ranges of the UC pack are between 680.4 V (14×48.6) to 340.2 V. The DC/DC converter, as an electrical interface, regulates the wide voltage range of the UC.

As shown in [16], the performance improvement of a HESS in comparison with the ESS is dependent on the aggressiveness of the driving cycle. Therefore, the design of a HESS and its power distribution control strategy could be done in a specific driving cycle to optimize the HESS performance. In this paper, the performance evaluation of the SHEB is studied in two different driving cycles for the city bus. The driving cycles are belong to Tehran [19] (Fig3) and Manhattan [20] (Fig4).

### 3. Power Distribution Control Strategy Development

The HESS power distribution control strategy has a great effect on its behavior. In this paper, two PDCS are developed and optimized in different driving cycles and hybrid vehicle controller. A common PDCS is the UC based one, and a new simple PDCS is established as a battery based one.

#### UC Based PDCS

The UC based PDCS flowchart is shown in Fig5. As a principle rule,  $P_{UC} = P_{dem}$  ( $P_{UC}$  is the UC power and  $P_{dem}$  is the HESS demand power). But, the  $P_{UC}$  is limited by the  $P_{UC\_min}$  (the minimum

level of the UC power) and the  $P_{UC\_max}$  (the maximum level of the UC power). The excess power of the HESS demand power which the UC cannot provide ( $P_{dem} - P_{UC}$ ) is generated by the battery ( $P_{bat}$ ). Likewise, the  $P_{bat}$  is limited by the  $P_{bat\_min}$  (the minimum level of the battery power) and the  $P_{bat\_max2}$  (the maximum level of the battery power).

#### Battery Based PDCS

The main idea of the battery based PDCS is to compensate the battery shortage powers. Thus, in these situations, the battery based PDCS commands the DC/DC converter to utilize the UC pack to provide the excess vehicle demand power. In addition, the PDCS charges the UC in the normal working modes, in order to prepare it for the next high power situation. The battery based PDCS flowchart is shown in Fig6. As a principle rule,  $P_{bat} = P_{dem}$ . But, the  $P_{bat}$  is limited by the  $P_{bat\_min}$  and the  $P_{bat\_max1}$  (the maximum continuous of the battery power). The battery can provide instantaneously higher power (up to  $P_{bat\_max2}$ ) than the maximum continuous power ( $P_{bat\_max1}$ ). But, if the  $P_{bat}$  goes over than the  $P_{bat\_max1}$ , the battery life-time is harmed. The excess power of the HESS demand power ( $P_{dem} - P_{bat}$ ) is generated by the UC ( $P_{UC}$ ). Likewise, the  $P_{UC}$  is limited by the  $P_{UC\_min}$  and the  $P_{UC\_max}$ . As the last rule,  $P_{bat} = P_{dem} - P_{UC}$  and  $P_{bat}$  is limited by the  $P_{bat\_max2}$  and  $P_{bat\_min}$ .

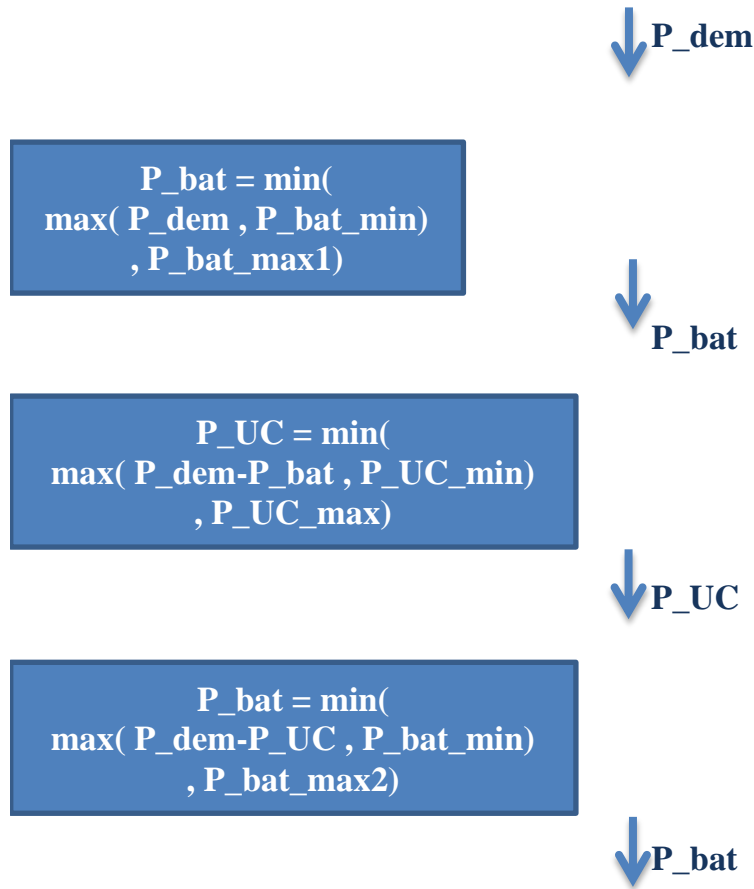

Fig6. Battery based PDCS flowchart

#### 4. PDCS Optimization

In this paper, four criteria are compared to the performance evaluation of ESS and HESSs:

Cycle count

- Sum of over-Continuous Current (Ah)
- Sum of Brake Resistor Power (kWh)
- Sum of Shortage Power (kWh)

In SHEB and other HEV application, there are a few complete charge/discharge cycles is applied to the battery. Therefore, it is difficult to estimate the battery cycle life. In this paper, a charge/discharge cycle counting method is utilized to estimate the Lithium battery cycle life [21], as the “cycle count”. This method can count the half charge/discharge cycles with widespread DoD ranges, similar to some methods for Lead-acid batteries [22]. By utilizing this criterion, an estimation of replacement cost of the

Lithium battery in real driving cycles is obtained. The main purpose of the PDCSs of the HESS is reducing the deep Depth of Discharge (DoD) cycles and the current fluctuations of the battery in comparison with an ESS.

The “sum of over-continuous current” indicates the high current stress of the battery which reduces the battery lifetime. Generally, batteries discharged at higher currents have lower discharge capacities [23]. The rate at which a battery charges and discharges has a clear effect on the capacity fade within batteries as observed by Ramadass et.al [24]. Therefore, the “sum of over-continuous current” can indicate the high current stress of the battery, which reduces the battery lifetime.

The “sum of brake resistor power” displays the energy saving loss which has been sent to the brake resistor (an ohmic resistor unit component) when the charge power capacity of the ESS is less than the vehicle charge power demand. Sequentially, The “sum of shortage power” presents the driver

satisfaction criteria. It is the difference between the ESS power demand and the ESS power provided. The shortage power causes to the driver cannot properly track the driving cycle.

For the battery based PDCS, four parameters are introduced for tuning the PDCS performance. The Design of Experiment (DoE) method is utilized to optimized the parameters of the battery based PDCS for the driving cycles and the vehicle controllers.

The design of experiments (Fig7) of the parameters of the battery based PDCS are listed below:

- The SoC<sub>n</sub> and SoC<sub>p</sub> varies from 20% to 95% with a step of 15%.
- The ch<sub>f</sub> and dch<sub>f</sub> varies from 0 to 1 with a step of 0.2.

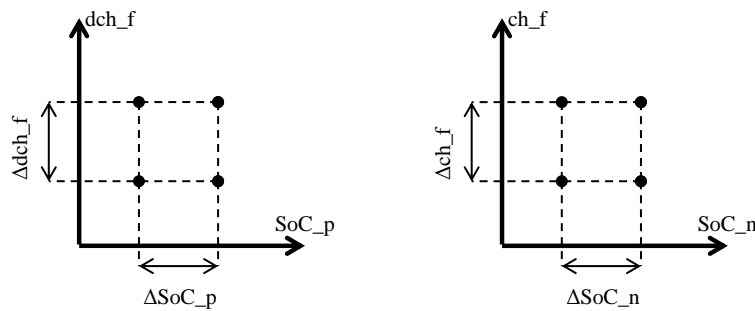

Fig7. Design of experiments for the battery PDCS parameters optimization

Table 4. Results for Tehran driving cycle

Performance	ESS	HESS UC based	HESS battery based
Cycle count	$4.14 \times 10^{-6}$	$1.45 \times 10^{-7}$	$4.14 \times 10^{-6}$
Sum of over-Continuous Current (Ah)	0.00	0.00	0.00
Sum of Shortage Power (kWh)	0.11	0.00	0.00
Sum of Brake Resistor Power (kWh)	15.91	0.00	0.00

Table 5. Results for Manhattan driving cycle

Performance	ESS	HESS UC based	HESS battery based
Cycle count	$9.80 \times 10^{-8}$	$2.41 \times 10^{-7}$	$1.60 \times 10^{-6}$
Sum of over-Continuous Current (Ah)	265.28	0.00	0.52
Sum of Shortage Power (kWh)	0.08	0.00	0.00
Sum of Brake Resistor Power (kWh)	1044.00	365.16	118.54

Table 6. Results for Tehran driving cycle

• Performance	ESS	HESS UC based	HESS battery based
Fuel Consumption (lit/100km)	40.12	35.11	39.90
Cycle count	$3.30 \times 10^{-5}$	$1.98 \times 10^{-7}$	$3.29 \times 10^{-5}$
Sum of over-Continuous Current (Ah)	1716.86	0.00	31.34
Sum of Shortage Power (kWh)	2.73	0.00	0.00
Sum of Brake Resistor Power (kWh)	6840.70	56.44	6445.61

Table 7. Results for Manhattan driving cycle

• Performance	ESS	HESS UC based	HESS battery based
Fuel Consumption (lit/100km)	59.09	47.38	46.61
Cycle count	$1.97 \times 10^{-6}$	$6.04 \times 10^{-5}$	$2.39 \times 10^{-6}$
Sum of over-Continuous Current (Ah)	7918.49	2397.75	189.68
Sum of Shortage Power (kWh)	0.08	0.00	0.00
Sum of Brake Resistor Power (kWh)	31297.93	8455.94	3998.76

## Conclusion

### Results

In tables VI and VII, the performance of the ESS is compared with the three different HESSs. The difference between these HESS is related to their PDCSs, as discussed in the previous section. The performance is determined in different driving cycles.

As shown in Table 6., the best power distribution control strategy for Tehran driving cycle is the UC based PDCS. The fuel consumption is 12.5%, the cycle count is 99.4%, and the other criteria are 100% improved for the HESS with the UC based PDCS in comparison with the ESS. On the other hand, the both of the battery based PDCSs do not have considerable good performance for Tehran driving cycle in comparison with the UC based PDCS.

As shown in 0 7, the best power distribution control strategy for these cases is the battery based PDCS. The fuel consumption is up to 29% and the other criteria are up to 100% improved for the HESS with the battery based PDCS in comparison with the ESS. On the other hand, the both other PDCSs do not have considerable good performance for Manhattan driving cycle in comparison with the battery based PDCS.

Power Distribution Control Strategies (PDCSs) are developed and optimized for Hybrid Energy Storage System (HESS) of a Series Hybrid Electric Bus (SHEB). A common UC based PDCS one was implemented. Also, a new simple PDCS was developed and implemented as a battery based one. For the battery based PDCS, four parameters were introduced for tuning the PDCS performance. The Design of Experiment (DoE) method was utilized to optimized the parameters of the battery based PDCS for two driving cycles and the vehicle controllers.

The performance evaluation shows that the optimized battery based PDCS performance for some cases is better than the UC based PDCS performance. Vice versa, for some cases the performance of the UC based PDCS is better than of the battery based one. In conclusion an appropriate PDCS structure should be designed and their parameters shall be optimized with respect to the SHEB driving cycle and the hybrid vehicle controller.

The estimation cost of the ESS (battery pack) is 24.85 1kUSD and the HESS (battery pack + UC pack + DC/DC converter) is 41.30 1kUSD (about 66% increases in cost). The performance evaluation of the developed PDCS shows that the battery life-time is increased at least two times for the HESS in



comparison with the ESS. Thus the increase in cost of the HESS using an appropriate PDCS is reasonable when considering the double improvement of the battery life-time.

#### Acknowledgment

This work was supported by Vehicle, Fuel and Environment Research Institute (VFERI), University of Tehran.

#### References

- [1]. W. Liu and J. Drobnik, "Challenges, Opportunities and Future of Electric Vehicles," in European Electric Vehicle Congress (EEVC), Brussels, Belgium, 2011.
- [2]. G. L. Berta, E. Durelli, and I. Nymann, "Simulation models for hybrid buses," Proceedings of the Institution of Mechanical Engineers, Part D: Journal of Automobile Engineering 212 (1), pp. 59-72, 1998.
- [3]. F. Sangtarash, V. Esfahanian, H. Nehzati, S. Haddadi, M. Amiri, and B. Haghpanah, "Effect of Different Regenerative Braking Strategies on Braking Performance and Fuel Economy in a Hybrid Electric Bus Employing CRUISE Vehicle Simulation," SAE International Journal of Fuels and Lubricants, 1 (1), pp. 828-837, 2009.
- [4]. M. Masih-Tehrani, M. Esfahanian, A. Mahmoudian, A. Manteghi, H. Nehzati, and M. Amiri, "Development of a feed-forward Model for the dynamic simulation of the series hybrid electric vehicles," presented at the 17th International conference on Mechanical Engineering, Tehran, Iran, 2009.
- [5]. S. M. Lukic, J. Cao, R. C. Bansal, F. Rodriguez, and A. Emadi, "Energy storage systems for automotive applications," IEEE Transactions on Industrial Electronics, vol. 55, pp. 2258-2267, 2008.
- [6]. R. M. Schupbach, J. C. Balda, M. Zolot, and B. Krmer, "Design Methodology of a Combined Battery-Ultracapacitor Energy Storage Unit for Vehicle Power Management," presented at the IEEE Power Electronics Specialists Conference, PESC'03, Hyatt-Regency Hotel, Acapulco, NM., 2003.
- [7]. W. Sierzchula, S. Bakker, K. Maat, and B. V. Wee, "The competitive environment of electric vehicles: An analysis of prototype and production models," presented at the European Electric Vehicle Congress (EEVC), Brussels, Belgium, 2011.
- [8]. M. Leiber. (2011, January 2011) Falling costs heighten appeal of ultracapacitors. Vehicle Electrification.
- [9]. P. Bubna, S. G. Advani, and A. K. Prasad, "Integration of batteries with ultracapacitors for a fuel cell hybrid transit bus," Journal of Power Sources, vol. 199, pp. 360-366, 2012.
- [10]. A. L. Allègre, A. Bouscayro, and R. Trigui, "Influence of control strategies on battery/supercapacitor hybrid Energy Storage Systems for traction applications," presented at

- the Vehicle Power and Propulsion Conference, IEEE, VPPC '09, Dearborn, MI, 2009.
- [11]. A. Burke, "Ultracapacitor technologies and application in hybrid and electric vehicles," *International Journal of Energy Resources*, vol. 34, pp. 133–151, 2010.
- [12]. Z. Amjadi and S. S. Williamson, "Power-Electronics-Based Solutions for Plug-in Hybrid Electric Vehicle Energy Storage and Management Systems," *IEEE TRANSACTIONS ON INDUSTRIAL ELECTRONICS*, vol. 57, pp. 608-616, 2010.
- [13]. H. Yoo, S.-K. Sul, Y. Park, and J. Jeong, "System Integration and Power-Flow Management for a Series Hybrid Electric Vehicle Using Supercapacitors and Batteries," *IEEE TRANSACTIONS ON INDUSTRY APPLICATIONS*, vol. 44, pp. 108-114, 2008.
- [14]. J. Dixon, I. Nakashima, E. F. Arcos, and M. Ortúzar, "Electric Vehicle Using a Combination of Ultracapacitors and ZEBRA Battery," *IEEE Transactions on Industrial Electronics*, vol. 57, pp. 943-949, 2010.
- [15]. M. Ortúzar, J. Moreno, and J. Dixon, "Ultracapacitor-Based Auxiliary Energy System for an Electric Vehicle: Implementation and Evaluation," *IEEE TRANSACTIONS ON INDUSTRIAL ELECTRONICS*, vol. 54, pp. 2147-, 2007.
- [16]. M. Masih-Tehrani, D. Bazargan, M. R. Hairi-Yazdi, and M. Esfahanian, "Performance analysis of hybrid energy storage in different driving cycles," in *Power Electronics, Drive Systems and Technologies Conference (PEDSTC)*, Tehran, Iran, 2011, pp. 330-335.
- [17]. M. Masih-Tehrani, M. R. Hairi-Yazdi, B. Haghpanah-Jahromi, V. Esfahanian, M. Amiri, and A. R. Jafari, "Design of an anti-lock regenerative braking system for a series hybrid electric vehicle," *International Journal of Automotive Engineering (IJAE)*, vol. 1, pp. 14-27, 2011.
- [18]. A. Burke and H. Zhao, "Simulations of Plug-in Hybrid Vehicles using Advanced Lithium Batteries and Ultracapacitors on Various Driving Cycles," *Technology*, Publisher: University of California-Davis, Institute of Transportation Studies, vol. 16, pp. 1-13, 2010.
- [19]. M. Montazeri-Gh, H. Varasteh, and M. Naghizadeh, "Driving Cycle Simulation for Heavy-Duty Engine Emission Evaluation and Testing," presented at the *Powertrain & Fluid Systems Conference & Exhibition*, San Antonio, TX, USA, 2005.
- [20]. The Manhattan Bus Cycle. Available: <http://www.dieselnet.com/standards/cycles/manhattan.html>
- [21]. M. Masih-Tehrani, V. Esfahanian, and M.-R. Hairi-Yazdi, "Energy Storage Hybridization for Lithium Battery Lifetime Improvement," presented at the 16th International Meeting on Lithium Batteries, Jeju, South Korea, 2012.
- [22]. E. Schaltz, A. R. Khaligh, and P. O. Rasmussen, "Influence of Battery/Ultracapacitor Energy-Storage Sizing in FCHEV," *IEEE Transactions on Vehicular Technology*, vol. 58, pp. 3882-3891, 2009.
- [23]. J. S. Kowski, "Advances in Lithium Ion Batteries Obviate Need for Ultracapacitors in Electric Vehicles," Master of Science in Electrical Engineering Thesis, College of Engineering and Computing, University of South Carolina, 2010.
- [24]. P. Ramadass, B. Haran, R. White, and B. N. Popov, "Capacity fade of Sony 18650 cells cycled at elevated temperatures: Part II. Capacity fade analysis," *Journal of Power Sources*, vol. 112, pp. 614-620, 2002.