

# Experimental Investigations about the Effect of New Combination of Biofuels on Simultaneous Reduction Of NO<sub>x</sub> and Smoke Emissions in DI-Diesel Engine

Masoud Iranmanesh<sup>1</sup>

1. Assistant Professor, Energy Department, Institute of Science and High Technology and Environmental sciences, Graduate University of Advanced Technology, Kerman, Iran

iranmanesh2001@yahoo.com

## Abstract

In this study, various percentage of DEE was added to the optimum selected ethanol-diesel blend (D-E10) and optimized its blending ratio to overcome the poor ignition quality of ethanol when utilized in a single cylinder DI diesel engine. Some physicochemical properties of test fuels such as heating value, viscosity, and density and distillation profile were determined in accordance to the ASTM standards. The heating value of the blends was reduced with addition of DEE. Front-end volatility of the blends was improved by addition of DEE, which in turn improves the cold starting property. The uncertainty associated with measurements was also measured. The data were analyzed statistically for 95% confidence level. The results have shown that addition of biofuels, ethanol and diethyl ether, have improved the combustion and emissions characteristics of the engine. Addition of ethanol and DEE improved smoke and NO<sub>x</sub> emissions simultaneously. It was found the 8% DEE add to the D-E10 blend is the optimum combination based on the performance and emission analysis with the exception of smoke opacity in which 15% DEE addition made the lowest smoke opacity. At this optimum ratio the minimum peak heat release rate, the lowest NO<sub>x</sub> emissions and the maximum BTE were occurred at full load condition. Meanwhile the lowest level of CO and HC emissions were obtained at all the load conditions with the same blending ratio.

**Keywords:** diesel, ethanol, diethyl ether, NO<sub>x</sub>, Smoke

## 1. Introduction

In spite of several benefits of diesel engines such as their high thermal efficiency, torque capacity, low CO and HC emissions, they suffer from high amount of soot, particulate matters and nitrogen oxides. The stringent emission norms cannot be met through engine design alone.

Several methods reported by various researchers [1, 2, 3 and 4] like retarding the injection timing, use of high injection pressure, EGR, split injection, modifying the combustion chamber geometry to enhance the swirl & squish are being tried to reduce emissions but, there are still problems in the operation of these techniques.

Improvement of fuel properties by introduction of oxygenated compounds such as alcohol has become essential for elimination of exhaust gas emissions from diesel engines [5].

Smoke formation in diesel engine is due to heterogeneous combustion and poor mixing of the fuel with air. An increase in oxygen enrichment of the fuel may reduce the smoke formation.

NO<sub>x</sub> emissions mostly are formed in high temperature regions where there is enough oxygen in the combustion chamber. Such a condition is mainly provided during premixed combustion period in diesel engine.

Simultaneous reduction of nitric oxides emissions and particulate matter is quite difficult due to the Soot/NO<sub>x</sub> trade off and is often accompanied by fuel consumption penalties.

Utilization of highly oxygenated additive like ethanol with 35% (by weight) oxygen content and low C/H ratio (0.33) seems to reduce smoke and particulate matter. The initial investigations into the use of ethanol in diesel engines were carried out in South Africa in the 1970s and continued in Germany and the United States during the 1980s [6]. However

using ethanol-diesel (E-Diesel) blend requires looking for the remedies to overcome the restrictions like limited solubility in diesel fuel, phase separation, extremely low cetane number and poor ignition characteristics [7]. Using a supplementary fuel with high cetane number and the ability of playing as a co-solvent in E-Diesel blend appears to be a promising approach to remove these barriers. Moreover, it will be desirable if this fuel could be oxygenated and produced from feed-stocks that are agro-based and therefore, renewable.

In this study, the selected candidate for this supplementary fuel was Diethyl ether (DEE). Diethyl ether can be used along with ethanol as an ignition improver with high cetane number (>125) and oxygen content of 21.6% (by weight) to overcome the above-mentioned restrictions. It can be used as a cold starting fluid for diesel engines and can be produced easily through dehydration of ethanol, which is a renewable biofuel [8]. Advantages of DEE over ethanol include its noncorrosive nature and its greater heating value. It can be mixed in any proportion in diesel fuel. However, the factors that make ethanol and diethyl ether (DEE) attractive as supplementary fuel are that they are oxygenated and renewable resources. Literature review indicates that significant work has not been carried out with respect to performance analysis and concerning pollution levels

of combination of ethanol and diethyl ether. Some properties of the fuels, which have been used in this study, are tabulated in Table 1.

Many researchers have investigated utilization of ethanol and diesel fuel in different techniques such as blending [9, 10, 11, 12, 13], dual fueling or fumigation [14, 15, 16] and using ignition improver technique [7,9]. But limited work has been reported using DEE as ignition improver and co-solvent with ethanol-diesel blend. Some researchers have used DEE as ignition improver for diesel fuel [17] or added to diesel-water emulsion [18] and with LPG in diesel engine [19]. A mixture of ethanol-diethyl ether as a fuel has been applied in alcohol diesel engine [20] and in HCCI engine [21] but optimum combination of ethanol-DEE with diesel fuel has not been carried out.

Savo Gjirja et al. [20] applied DEE as ignition improver directly by blending or separately fumigated in alcohol diesel engine and different injection timing. They derived the optimum fraction of ETOH/(ETOH+DEE) between 40-60% and for both techniques a blend of 50% DEE and 50% ETOH with earlier injection timing led to a shorter ignition delay and better performance. Dale et al. [22] indicated that diethyl ether produced less particulate for a given level of NO<sub>x</sub> and the flame temperature has the overriding variable of importance in NO<sub>x</sub> formation for both fuels. Dhanasekaran et al. [23]

**Table 1:** properties of oxygenated fuels and diesel fuel used in this study [25]

Properties	Diesel	DEE	Ethanol
Chemical Structure	C <sub>10</sub> to C <sub>20</sub>	C <sub>2</sub> H <sub>5</sub> -O- C <sub>2</sub> H <sub>5</sub>	CH <sub>3</sub> CH <sub>2</sub> OH
Specific gravity @15 °C	0.86	0.714	0.794
Viscosity(C.P.) mm <sup>2</sup> /sec (40 °C)	2.6-4.1	0.23	1.19
Auto ignition point(°C)	316	160	420
Lower Heating Value (MJ/kg)	42	33.9	27
Cetane Number	40 to 55	>125	<8
Upper Flammability.	7.6	36	19
Limit (%vol) lower	1.4	1.9	4.3
Oxygen content (by%Wt)	0	21	34.7
Boiling point (°C)	180-360	35	78.0
Stoich. A/F Ratio	14-14.7	11.2	9.06
Latent Heat of Vaporization (kJ/Kg )	233	356	923

**Table-2:** Engine specifications

1. Model	Kirloskar Diesel engine Model TAF1
2. Type of engine	4- stroke , single cylinder, air-cooled, naturally aspirated
3. Bore × Stroke	87.5 mm x 110 mm
4. Compression ratio	17.5:1
5. Rated power out put	4.7kW at 1500rpm
6. Fuel injection pressure	196 bar

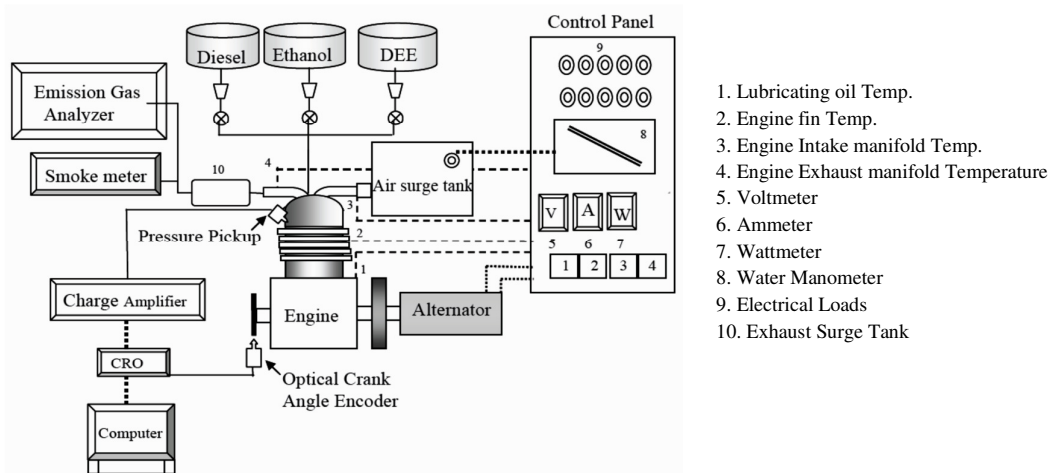
**Fig1.** schematic diagram of experimental setup

have studied DEE as an ignition source in a diesel engine in which hydrogen was used in neat form. DEE was introduced in the manifold follows the hydrogen injection. DEE mixed with air and flows into the combustion chamber as DEE auto ignites first followed by hydrogen combustion.

In this work, DEE with different ratios was added to the optimum ethanol-diesel blend (D-E10) which was found by the author [24] in the previous work Based on performance and emission analysis. Hence, this blending ratio was selected as the baseline fuel.

for this study to add DEE as ignition improver to overcome the poor ignition quality of ethanol.

The purpose of this investigation is to find out the optimum amount of supplementary combination of ethanol and DEE by blending with diesel fuel, which

is named as "Diesolther" by the author, when lower emissions, especially NO<sub>x</sub> and smoke emissions and better performance without any considerable modifications in engine is desired.

## 2. Experimental Description and Test Procedure

### 2.1 Test Setup

The experiment was conducted on a commercial single cylinder, four strokes, air cooled, diesel engine whose major technical specifications are given in Table 2.

First of all the engine was overhauled, a new injector, an injection pump and piston rings were replaced, and fresh lubricating oil was filled in the oil sump before starting the experiments. The engine was

optimized for diesel operation to provide sufficient baseline for the assessment of the different blends. Furthermore, engine operation has been optimized for the blends before making comparisons.

The engine was coupled to a single phase, 220-230 Volts, 5 KVA, 50 Hz frequency and AC alternator. The alternator was used for loading the engine through a resistive load bank. The load bank consists of 25 lighting bulbs (200 W each) and their switches provided on the load control panel. The schematic layout of the experimental setup for the present investigation is shown in Figure 1.

Exhaust gas opacity was measured using smoke opacity meter (AVL 437 Model). The exhaust gas composition was measured using AVL DiGas 4000 series five-gas analyzer. It measures CO<sub>2</sub>, CO, HC, O<sub>2</sub> and NO<sub>x</sub> concentrations in the exhaust gas. To measure the cylinder gas pressure, a piezoelectric pressure transducer (Kistler model 601A) equipped with a water-cooled adapter was used. A charge amplifier (Kistler model 5011) amplified the charge output from this transducer. A rotary optical encoder was used to measure the crank angle. The output signals were sent to a data acquisition system i.e.

personal computer through an oscilloscope (Tektronix TDS 2014).

## 2.2 Fuel Preparation and Properties

In this experiment two types of ethanol has been used, pure ethanol (99.9%) and analysis-grade ethanol (99.5%) which is easily available. Fuel formulations were made in two steps. Firstly, to make E-Diesel blends with different ratios, 200 proof ethanol (5, 10 and 15% on a volume basis) was added to diesel fuel and then the blending ratio was optimized based on stabilization studies, performance and emissions characteristics. Stabilization study was carried out to find out the maximum allowable amount of ethanol, which can blend with diesel fuel without any additive requirement such as emulsifier or co-solvent. The results that are shown in table 3 and 4 indicated that addition of ethanol up to 5% to diesel fuel is stable. A blend of pure ethanol with up to 10% addition to diesel fuel at more than 10 oC also is stable. E-diesel blend containing more than 15% ethanol is generally unstable.

**Table 3:** The results of stabilization test for ethanol-diesel blend without any stabilizer

Mark	Blended Fuel Composition (Vol.%)		Stable <sup>(2)</sup> Resident Time	Low Stability Limit T (oC)
	HSD <sup>(1)</sup> (%Vol.)	Ethanol (%Vol.)		
DE05 (P)	95	5	8 M	S
DE05	95	5	8 M	S
DE10 (P)	90	10	1M	10
DE10	90	10	5 D	25
DE12 (P)	88	12	8D	25
DE12	88	12	-	US
DE15(P)	85	15	8D	25
DE18(P)	82	18	-	US
DE20(P)	80	20	-	US

1-High Speed Diesel

2- Month (M), Days (D) P: Pure ethanol

At the second step, various percentages of diethyl ether (5, 8, 10 and 15% on a volume basis) were added to the optimum E-Diesel blend to improve its ignition properties. In this study some properties such as calorific value, density, viscosity, and distillation profile were measured for all of the blended fuels.

It was found that diethyl ether with high ignition quality can also act as a powerful co-solvent when using more than 15% of ethanol in the diesel blend to stabilize them. Roughly, for every 3 to 4 percent (vol.) of ethanol added to diesel fuel requires 1 % (vol.) DEE as a co-solvent.

Based on the standard procedure, ASTM D86, the distillation tests were carried out for different blends of ethanol and DEE with diesel fuel. The results are shown in Figure 2. It can be seen that vapor

temperature for diesel is higher than its blends with ethanol or DEE for the majority of the test duration. However, adding ethanol or DEE increases the front-end volatility of the blends because the ebullition point of ethanol or DEE, as a pure compound, is lower (78°C and 35 °C respectively) than that of diesel.

It was observed that initial boiling point (IBP) of diesel fuel is 142 °C while a 15 % blend of DEE in E-diesel shows an initial boiling point of only 38 °C. The DEE gives high front-end volatility to the blend and this will help in improving cold starting accordingly as it is demonstrated by Clothier et al [30]. There is no significant difference observed in the tail-end volatility of E-diesel and its blends with DEE as seen in Figure 2.

**Table 4:** Effect of DEE as a co-solvent on the stabilization of ethanol-diesel blend

Mark	Blended Fuel Composition (Vol. %)			Stable Resident Time (2)	Low Stability Limit T (°C)
	HSD(1) (%Vol.)	Ethanol (%Vol)	Add. Stabilizer DEE		
DE10-DEE02	88	10	2	-	Us
DE10-DEE05	85	10	5	5M	S
DE12-DEE03	85	12	3	2M	15
DE12-DEE04	84	12	4	5M	S
DE15-DEE05	80	15	5	2M	S
DE20-DEE05	75	20	5	2M	S

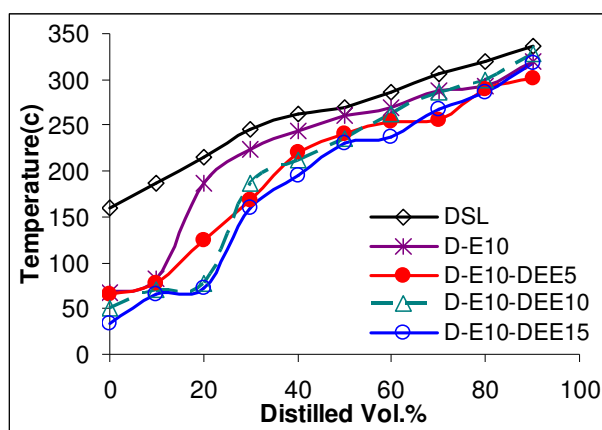

**Fig2.** Distillation profile for DEE blend with the optimum blend of Diesel-Ethanol (10%).

**Table 5:** Properties of test fuels

Type of fuels	kinematic Viscosity(cst) @40 oC	C.V. (MJ/Kg)	Density Kg/m3 @ 20 oC	Oxygen content (%wt)
Diesel	2.49	45.986	820.4	0
D-E 10	2.3693	43.232	812.4	3.47
D-E10-DE5	1.9613	42.993	809.6	4.55
D-E10-DE8	1.7105	42.00	807.1	5.20
D-E10-DE10	1.6826	41.67	804	5.63
D-E10-DE15	1.57	40.75	801.5	6.71

Some other properties of diesel fuel as the baseline, and its blends with ethanol and DEE such as calorific value (C.V.), density and kinematic viscosity were evaluated in the laboratory according to the ASTM standards. Viscosity was measured by a Stevis viscometer, according to the ASTM test method D445 at a constant temperature of 40°C. The calorific value was obtained using the isothermal bomb calorimeter, Rajdhani make, according to the ASTM test method D240. The density was measured following the ASTM D941. The procedure was followed by using 50 ml capacity pycnometer and a precise electronic balance with the range of 0-4000 g having readability of 0.001 g. The above-mentioned properties are given in Table 5. It is seen from table 3 that with addition of DEE the oxygen content of the blends are improved and all the properties such as calorific value, density and viscosity are reduced.

### 2.3 Test Procedure

The engine was optimized for diesel operation to provide sufficient baseline for the assessment of the different blends as explained earlier. Furthermore, engine operation has been optimized for the blends before making comparisons. The engine was run on no-load condition and its speed was adjusted to 1300 ±5 rpm by adjusting the screw provided with the fuel injector pump rack. The engine was run to gain uniform speed after which it was gradually loaded. The experiments were conducted at different load levels, namely, no load, 25, 50, and 75% of full load and full load. For each load condition, the engine was run for at least 5 minutes after which data was collected. The experiment was replicated at least three times and the average value was taken. To ensure the repeatability of the experiments, testing of the engine was done as per the standard (IS 10000 Part IV and IS 14599). The observations made during the test for the

determination of various engine parameters included brake load, engine speed, time for blends consumption, drop in air pressure across the orifice of the air-stabilizing tank, exhaust gas temperature and exhaust emissions.

### 3. Heat Release Analysis

A lot of series of experimental pressure data were collected and averaged to use for the heat release analysis. Heat release rate was calculated by this averaged pressure data over 100 successive cycles. Heat release analysis of ethanol and DEE blended fuels have been derived based on the traditional single-zone model of thermodynamic first law equation. The equation of heat release rate (gross) is obtained as follows:

$$\frac{dQ_{ch}}{d\theta} = \frac{\gamma}{\gamma-1} p \left( \frac{dV}{d\theta} \right) + \left( \frac{1}{\gamma-1} \right) V \left( \frac{dp}{d\theta} \right) + \frac{dQ_{ht}}{d\theta} \quad (1)$$

The term  $dQ_{ch} / d\theta$  represent the chemical energy released by combustion (gross heat release rate) and  $dQ_{ht} / d\theta$  is heat transfer from charge to the chamber walls which is determined with a Newtonian convection equation:

$$\frac{dQ_{ht}}{d\theta} = h_c(\theta) \cdot A_w(\theta) \cdot (T_g(\theta) - T_w) \left( \frac{1}{6N} \right) \quad (2)$$

In the above equation  $T_w$  is the area-weighted mean temperature of the exposed cylinder wall, the head, and the piston crown. The exposed cylinder area  $A_w(\theta)$  is the sum of the cylinder bore area, the cylinder head and the piston crown area, assuming a flat cylinder head. The gas side heat transfer coefficient  $h_c(\theta)$  in the cylinder can be estimated by Hohenberg's correlation as follows:

$$h_c = 129.8 \frac{P_{\theta}^{0.8}}{V_{\theta}^{0.06} T_g^{0.4}} (S_p + 1.4)^{0.8} \quad (3)$$

Where

hc = Heat transfer coefficient, W/m<sup>2</sup>-K  
 P $\theta$  = Instantaneous cylinder pressure, bar  
 Sp = Mean Piston Speed, m/s  
 V $\theta$  = Instantaneous cylinder volume, m<sup>3</sup>  
 Tg = Cylinder charge temperature, K

The start of combustion (SOC) was defined as a location where the gross heat released is 1% of the total fuel energy. The combustion duration is evaluated based on the difference between start of combustion and end of controlled combustion near the end of combustion, which is defined as the difference between CA90 and CA10.

#### 4. Uncertainty Statistical Analysis

The uncertainty in measurement is estimated based on the procedure given by Kline and McClintock [12]. It is defined by the following equation:

$$\frac{\omega_R}{R} = \frac{1}{R} \sqrt{\left(\frac{\partial R}{\partial V_1} \omega_1\right)^2 + \left(\frac{\partial R}{\partial V_2} \omega_2\right)^2 + \dots + \left(\frac{\partial R}{\partial V_n} \omega_n\right)^2} \times 100\% \quad (4)$$

Where, R is the result of which uncertainty is to be estimated.  $\omega_n$  is the uncertainty in the result. Vi (i=1 to n) are the variables of which R is a function.

The experiments were conducted six times with base fuel and optimal blends to carry out statistical analysis at 95% confidence level.

The mean ( $x_m$ ), deviation  $|d_i|$  and standard deviation (S) of the results at different load were calculated by:

$$x_m = \frac{1}{n} \sum_{i=1}^n x_i$$

$$S = \left[ \frac{1}{n} \sum_{i=1}^n (x_i - x_m)^2 \right]^{1/2}$$

$$|d_i| = |x_i - x_m| \quad (5)$$

Chauvenet's criterion was applied to eliminate dubious data points, the deviation of the individual points was then compared with the standard deviation

and the dubious points were eliminated. For the final data, presentation a new mean and standard deviation were computed with the dubious points eliminated from the calculation. The confidence interval was estimated by Student's t- Distribution

$$\Delta = \frac{tS}{\sqrt{n}}$$

Where,

$\Delta$  = Confidence interval

t= Random variable; values of the same are given in [12] at different degree of freedom,  $\nu = n-1$

n= number of observations.

The mean values of emissions and engine parameters of different blends were compared with base fuels. The results were analyzed statistically for 95% confidence level.

Table 6 shows mean value, confidence interval and standard deviation of emissions at 100% load with the optimum blend (D-E10-DEE8. Accuracies of measurements and uncertainties of derived calculated parameters are shown in Table 7. Both tables are placed in the appendices at the end of this paper.

#### 5. Result and Discuss

Using oxygenated additives like ethanol or diethyl ether by blending will enrich the oxygen content of the fuel-air mixture and it is expected to improve combustion and emissions characteristics of the engine. However the behavior of oxygenated additives and their effect on tailpipe emissions depends on the physical and chemical properties of oxygenated fuels like ignition quality, structure of molecule, type of oxygenate and latent heat of evaporation.

Ethanol with high fuel-bounded oxygen content (35% w) has the potential to reduce soot and PM .Diethyl ether with 21% w oxygen content and high ignition quality (high cetane number and low auto ignition temperature) for diesel engines can either play the role of co-solvent or boost the emission improvement when blended with ethanol.

It is already mentioned earlier in the above that the optimum blending ratio of E-Diesel was D-E10 which was selected as the baseline fuel for this study to add DEE as ignition improver to overcome the poor ignition quality of ethanol.

Performance and emission trends of the engine with different amount of DEE addition to D-E10 blend (denoted as D-E-DEE) are indicated in figures 3 to 9

**Table 6:** Mean values, Confidence interval (C.I.) and uncertainty of emissions (g/Kw.h) and performance for the optimum E-DEE-Diesel blend.

Bmep (bar)	NO <sub>x</sub> (g/Kwh)	C.I.	Uncert.*	Smoke (%)	C.I.	Uncert.*	HC (g/Kwh)	C.I.	Uncert.*
			±0.0			0.0		0	±0.0
0.00	0.00	0.00	0	18.80	0	±0.94	0.00	.00	0
			±0.5			18.		0	±0.0
1.40	10.99	4.60	5	40.38	76	±2.02	1.05	.15	5
			±0.5			20.		0	±0.0
2.80	10.01	4.16	0	60.00	82	±3.00	0.69	.14	3
			±0.4			12.		0	±0.0
4.20	8.54	2.87	3	79.68	45	±3.98	0.63	.22	3
			±0.3			3.8		0	±0.0
5.60	7.31	2.91	7	94.08	5	±4.70	0.54	.19	3

Bmep (bar)	CO (g/Kwh)	C.I.	Uncert.*	BTE	C.I.	Uncert.*
			±0.0			0.0
0.00	0.00	0.00	0	0.00	0	±0.00
	39.2	20.9	±1.9			0.0
1.40	2	5	6	0.17	0	±0.85
	19.3	10.6	±0.9			0.0
2.80	4	5	7	0.26	0	±1.32
	23.4	10.6	±1.1			0.0
4.20	3	8	7	0.31	2	±1.53
	67.6	32.7	±3.3			0.0
5.60	9	1	8	0.30	1	±1.51

**Table 7:** Accuracies of measurements and uncertainties of derived calculated parameter

Parameters	unit	Uncertainties Max (%)
BP	kw	±1.27
BTE	%	±1.53
CV	kJ/kg	±0.15
Density	kg/m <sup>3</sup>	±0.2
Vol. fuel flow rate	ml/s	±1

The effect of DEE addition to E-Diesel blend on the NO<sub>x</sub> emissions is displayed in Figure 3. It can be seen the NO<sub>x</sub> emissions were decreased significantly with increasing DEE at the same load.

Besides the effect of high latent heat of vaporization, the combustion characteristics of DEE will help in further reduction of NO<sub>x</sub>. According to

the in cylinder pressure and heat release profiles (Figures 4 and 5) combustion starts with delay for all of diethyl ether blends with baseline fuels and it becomes more prominent with higher diethyl ether blends.

As the quantity of DEE in the blends increase, dynamic injection timing was altered due to problems



encountered with the fuel pump and lowering the density, viscosity and bulk modulus of the blends [22] which leads to late injection and consequently ignition retard [28, 33]. Then the start of combustion and heat release is postponed and this is in agreed with some other researchers like Clothier [30], Dale [22] and Mohanan [27]. Moreover, due to high latent heat of DEE, the peak pressure and peak HRR were suppressed, hence as a result of these two factors NOx emissions drastically reduced.

Among all the effective factors on NOx formation, the combustion temperature is the dominating process. Ethanol and DEE blending into diesel fuel reduces temperature both by increased heat of vaporization and by reduced flame temperature [34]. Consequently, combustion temperature abates, and hence NOx emissions are diminished. It can be seen in Figure 3 that D-E-DEE 8 at full load condition has the lowest NOx emissions and the minimum peak HRR in Figure 5 that may relate to the NOx emissions and support this result.

Finally, the blend of D-E10-DEE8 has the lowest NOx emissions such that 36.6% and 43%

improvement was observed at full load condition in compare with D-E10 blend and neat diesel fuel respectively as illustrated in Figure 3. Meanwhile, for all the load conditions except for full load, D-E-DEE15 is the optimum blend to reduce NOx emissions.

The smoke opacity traces with respect to brake mean effective pressure for diesel blends with ethanol and diethyl ether is illustrated in Figure 6. The general trend of smoke opacity displays a reduction with addition of oxygenates due to oxygen content in ethanol and DEE which helps in an improved combustion than neat diesel fuel.

Since the smoke is produced mainly in the diffusive combustion phase, the addition of oxygenated fuel leads to an improvement in diffusive combustion [35]. On the other hand enhancing the oxygen content in the charge, can overcome poor mixing of the fuel with air, which is responsible for smoke formation in diesel engines.

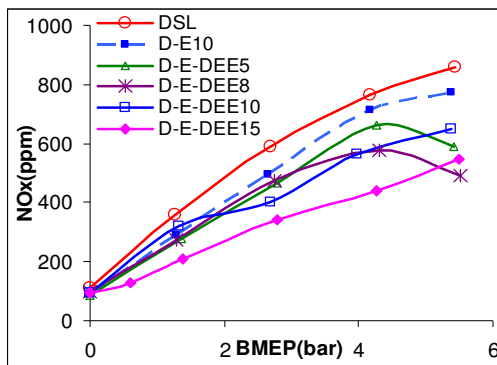

Fig3. NO<sub>x</sub> emissions versus BMEP for different DEE percentage add to D-E10 blend

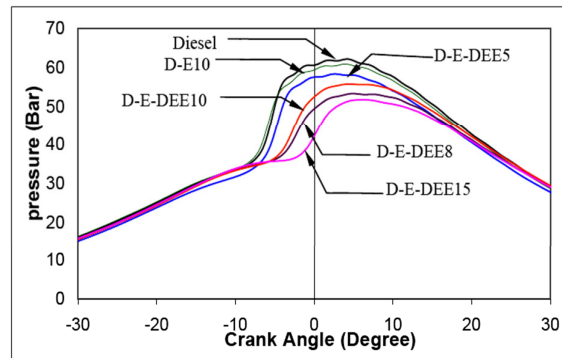

Fig4.: In cylinder pressure versus crank angle for various DEE additions to D-E10 blend at full load condition.

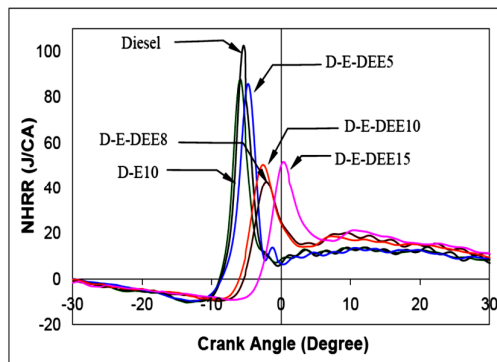

Fig5. Net Heat Release Rate versus crank angle for various DEE Vol. (%) additions to D-E

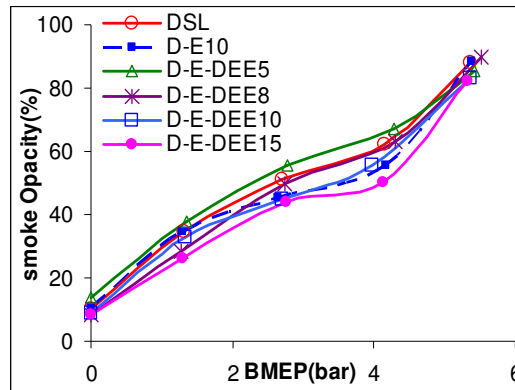

Fig6.: Effect of DEE on Smoke opacity

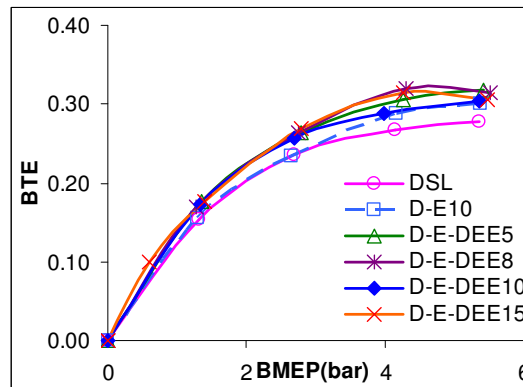

Fig7.Effect of DEE on Brake thermal efficiency

In overall, the results exhibit that the smoke opacity with DEE blends was found to be slightly reduced as compared to the base fuels. However this reduction is not as much as expected considering its oxygen content especially for the small amount of DEE, typically for 5%DEE in which a little increase in smoke emission was seen in Figure 6. This might be due to the trade off between its oxygen content and latent heat of vaporization (LHV). It means the oxygen content of DEE leads to smoke reduction [29, 30] but its latent heat decreases the combustion temperature and consequently unburned HC increases due to wall quenching effects and finally smoke will increase by hydrocarbons oxidation. Moreover, adding DEE to the blends leads to longer heat release delay and hence it can improve the adverse effect on smoke emissions. This result is in agreement with the findings of Annand [1]. However, based on the

results presented in Figure 6 addition of 15% DEE to the D-E10 blend has shown the lowest smoke opacity at all of the load conditions.

It is seen from Figure 7 that brake thermal efficiency (BTE) has improved with ethanol and further improved by DEE addition to diesel fuel. It may due to improved combustion in the fuel-rich zone due to the presence of oxygenate. Based on the results obtained by Wu, et al, (2006) and He, et al., (2008) the Viscosity, density and bulk modulus properties of the oxygenated fuel play a significant effect on the improvement of atomization behavior. They found that the spray quality of low viscosity oxygenates (like ethanol and DEE) blended fuels improve and a finer droplet, a stronger interface between fuel spray and surrounding gas perform when compared to that of diesel. Hence the combustion efficiency is enhanced, heat losses

decrease in the cylinder due to lower flame temperature of ethanol or DEE blend than that of diesel [32].

The thermal efficiency is a more representative reflection of the fuel economy when operating on oxygenated fuels [36]. The other parameters like Brake Specific Fuel Consumption (BSFC) and Brake Specific Energy Consumption (BSEC) are almost adverse of BTE and they will not show different physical meaning of performance, then they are not discussed here. For the combination of Ethanol-DEE with diesel fuel, the blend of D-E10-DEE8 has the maximum BTE in which 5.6% and 14% improvement was observed at full load condition in compare with D-E10 blend and neat diesel respectively as illustrated in Figure 7.

The Effect of DEE addition to the optimum selected ethanol blended fuels (D-E10) on the brake specific carbon monoxide (BSCO) is shown in Figure 8. The results of CO emissions from DEE–diesel blends presented by different researchers are various. Some studies reported reduction of CO emissions by using DEE [30, 18] while opposite results was also observed [1, 20].

All the following trends show the variation of CO emissions versus BMEP follows almost the same trends as ethanol blends in the previous work by the author [24]. However, it is seen that there is no significant difference between DEE blends with base fuels at lower loads but at higher loads for larger amount of DEE (more than 10% in the blends), an increase of CO emission is observed.

The reason may be explained by the fact that besides the effect of high latent heat of vaporization that leads to temperature reduction, the theory of CO formation holds that, in the premixed combustion

phase, the CO concentration increases rapidly to the maximum value in the flame zone. The CO formed via this path is then oxidized to CO<sub>2</sub> but at a slower rate [37]. Therefore, one possible explanation for the increase of CO by addition of DEE (especially for the large amounts) is injection timing delay and consequently retarding onset of combustion as already illustrated in Figures 4 and 5, hence less time is available for the oxidization process and leaving more CO in the exhaust. Moreover, the erratic operation of the engine with high amount of DEE addition as already explained earlier may be another reason of CO formation due to rough burning and miss firing.

However, based on the results shown in Figure 8 the blend D-E-DEE10 at full load condition is the optimum blend to reduce CO emission. Meanwhile in overall (at all of the load conditions) the blend D-E-DEE8 exhibits the lowest CO emission and show improvement CO compared with base fuel by 4.38%.

The variations of brake specific unburned hydrocarbon emissions (BSHC) versus BMEP with the effect of DEE addition to the optimum selected ethanol blended fuels (D-E10) are shown in Figure 9. It is seen that the HC emissions have a moderate increase for the ethanol and all DEE additions to the base fuel at lower loads but it increases marginally at higher loads. This can be explained by the lower oxygen concentration in the blends and incomplete combustion at lower loads. Further, by increasing load the injected fuel and consequently oxygen content is increased as well as peak temperature of gas inside the cylinder and hence the higher the load the larger oxidation of the products and the lower the HC emissions

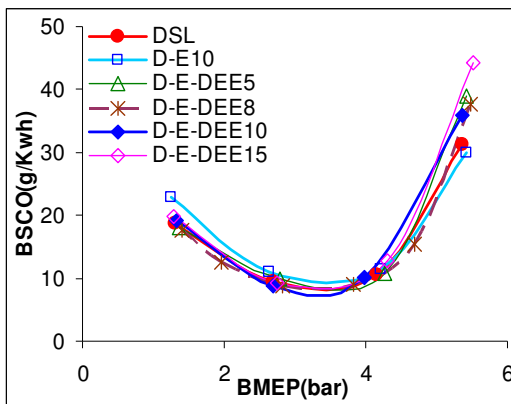

Fig8.: Effect of DEE on brake specific CO emission

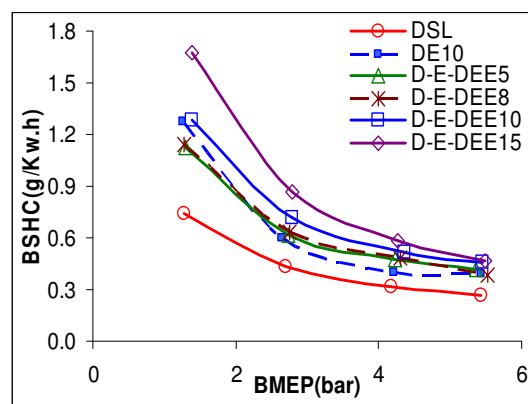

Fig9. Effect of DEE on brake specific HC emission

The results of HC emitted by utilization of DEE in diesel engine presented by different investigators are similar to CO emissions. Some studies reported increase of HC emissions by using DEE [1, 17, 19, 20,] while some results on the contrary side were also observed [18, 30]. The increase of HC with the addition of DEE as well as ethanol may due to the following reasons:

One is the higher heat of evaporation of the ethanol or DEE in the blends which tends to produce slow vaporization and poorer fuel-air mixing which leading to incomplete combustion of the mixture. Another one is the increased spray penetration causing undesired fuel impingement on the chamber walls and so flame quenching and cushioning in the ring land areas. The third is related to the so-called 'lean flame out region' (LFOR). This region is referred to a region near the outer edge of the spray in which, the mixture is often observed to be too lean to ignite or to support stable combustion. Lower temperatures and pressures extend this region and increase HC [38].

Moreover this may also contribute the late escape into the cylinder of the fuel left in the nozzle sac volume, because with the addition of ethanol or DEE this is more easily evaporated (as heated) and 'slipped' into the cylinder (at low velocity, late in the expansion stroke) [38].

In summary, the results of Figure 9 show that 8% DEE to the optimum selected ethanol blended fuels (D-E10) have the lowest level of HC emission at full load condition and in overall for all the loads.

### Conclusion

In this investigation it was found that using oxygenated additives, ethanol and diethyl ether, by blending have improved the combustion and emissions characteristics of the engine. However, due to some barriers to use of ethanol in diesel engine, DEE was added to the optimum selected E-Diesel blend (D-E10) and optimized its blending ratio to overcome the poor ignition quality of ethanol.

Salient features of the conclusions that were obtained based on this experimental investigations using various DEE blends are as follows:

Some physicochemical properties of D-E10 blend such as ignition quality, boiling point, oxygen content and distillation profile were improved by addition of DEE. It can also act as a powerful co-solvent when add to E-Diesel blend. Front-end volatility of the blends also improved, which in turn improved the

cold starting property. The heating value, density and viscosity of the blends reduced with addition of DEE.

The addition of 8% DEE to D-E10 was found to be the optimum blending ratio based on the performance and emission analysis with the exception of smoke opacity in which 15% DEE addition made the lowest smoke opacity.

The lowest NOx emissions and the minimum peak HRR was obtained with the blend D-E10-DEE8 at full load condition in which 36.6% and 43% improvement was observed in compare with D-E10 blend and neat diesel respectively. Meanwhile, for all the load conditions except for full load, D-E-DEE15 has the lowest NOx emissions.

The highest amount of BTE was obtained with the blend D-E10-DEE8. An improvement of 5.6% and 14% was observed at full load condition in compare with D-E10 blend and neat diesel respectively.

The lowest level of CO and HC emissions were obtained with addition of 8% DEE to the optimum selected ethanol blended fuels (D-E10) at full load condition and in overall for all the loads.

### Acknowledgments

The author acknowledges Institute of Science and High Technology and Environmental sciences for their financial supporting of the author to pursuing this project.

The author also acknowledges I.C.Engine Laboratory, Department of Mechanical Engineering, Indian Institute of Technology, Delhi for their help in conducting the experiments and supplying the required materials for the test

### References

- [1]. Anand, R. and Mahalakshmi, N V., "Simultaneous reduction of NOx and smoke from a direct injection diesel engine with exhaust gas recirculation and diethyl ether", 2007, Proc. IMechE Vol. 221 Part D: J. Automobile Engineering
- [2]. Rogak, S, "The Clean Diesel Engine: Myth or Reality?", 2005, Presentation in Department of Mechanical Engineering, University of British Columbia
- [3]. Miyamoto, N., Ogawa, H., Nurun, N. M., Obata, K., and Arima, T., "Smokeless, Low NOx, High Thermal Efficiency, and Low Noise Diesel Combustion with Oxygen ated Agents as Main Fuel", 1998, SAE paper No.980506
- [4]. Bertoli, C.,Del Giacomo, N.and Beatrice, C., 1997," Diesel Combustion Improvements By

- [5]. the Use of Oxygenated Synthetic Fuels”, 1997, SAE technical paper No.972972
- [6]. Nurun Nabi, Md. Masahiro Minami, Hideyuki Ogawa and Noboru Miyamoto, “Ultra Low Emission and High Performance Diesel Combustion with Highly Oxygenated Fuel”, 2000, SAE Paper 2000- 01-0231
- [7]. Satge’ P. de Caroa, Z. Moulounguia,, G.Vaitilingomb, J.Ch. Bergec “Interest of combining an additive with diesel–ethanol blends for use in diesel engines” Fuel 80 (2001) 565–574
- [8]. Lu, X.C., Yang, J.G., Zhang, W.G., Huang, Z., “Effect of cetane number improver on heat rate and emissions of high speed diesel engine fueled with ethanol–diesel blend fuel”, Fuel Vol. 83, Issues 14-15, October 2004, 2013–2020.
- [9]. Bailey, B., Guguen, S. and Erwin, J., “Diethyl Ether (DEE) as a Renewable fuel”, 1997, SAE Paper: 972978
- [10]. He, B.Q., Shuai, S. J., Wang, J. X. and He, H., “The effect of ethanol blended diesel fuels on emissions from a diesel engine”, 2003, Atmospheric Environment 37, 4965–4971
- [11]. Mohammadi, A., Ishiyama, T., “ An Optimal Usage of Recent Combustion Control Technologies for Di Diesel Engine Operating on Ethanol-Blended Fuels”, 2004, SAE Paper: 2004-01-1866
- [12]. Satge’ P. de Caroa, Z. Moulounguia,, G. Vaitilingomb, J.Ch. Bergec “Interest of combining an additive with diesel–ethanol blends for use in diesel engines” Fuel 80 (2001) 565–574
- [13]. Ajav E.A., Bachchan Singh and Bhattacharya T.K. “Experimental study of some performance parameters of a constant speed stationary diesel engine using ethanol–diesel blends as fuel” Biomass and Bioenergy, Volume 17, Issue 4, October 1999, Pages 357-365
- [14]. Chandan Kumar, M.K.G.Babu, L.M.Das “ Effects of Ethanol Addition on Performance, Emission and Combustion of DI Diesel Engine Running at Different Injection Pressures” SAE Paper: 2007-01-0626
- [15]. E. A. Ajav, Bachchan Singh And T. K. Bhattacharya “Performance Of A Stationary Diesel Engine Using Vapourized Ethanol As Supplementary Fuel” Biomass and Bioenergy Vol. 15, No. 6, pp. 493-502, 1998 Published by Elsevier Science
- [16]. Subramanian R “Reduction of NO<sub>x</sub> and Smoke emissions in a DI Diesel engine-Ethanol Dual fuel engine “Proc.Int.conference on Energy and environmental technologies for sustainable development-2003,India, Jaipur p:213-219
- [17]. M. Abu-Qudais, O. Haddad, M. Qudaisat, “The effect of alcohol fumigation on diesel engine performance and emissions” Energy Conversion & Management 41 (2000)
- [18]. Venkatachalam.R “Diethyl Ether (DEE) as Cetane improver for Diesel fueled engine” proc. of Int.Conference on Energy and environmental technologies for sustainable development-India-jaypur-Oct.2003
- [19]. K.A.Subramanian and A.Ramaesh “Use of Diethyl Ether along with water-diesel emulsion in a DI Diesel engine “, SAE Paper 2002-01-2720
- [20]. N.K. Miller Jothi, G. Nagarajan , S. Renganarayanan “Experimental studies on homogeneous charge CI engine fueled with LPG using DEE as an ignition enhancer” Renewable Energy (2006), doi:10.1016/j.renene.2006.08.007
- [21]. Gjirja, S., Olsson, E., Karistr.om, A., 1998. Considerations on engine design and fuelling technique effects on qualitative combustion in alcohol diesel engines. SAE Technical Paper Series 982530
- [22]. J.H. Macka, D.L. Flowersb, B.A. Buchholz, R.W. Dibble “Investigation of HCCI combustion of diethyl ether and ethanol mixtures using carbon 14 tracing and numerical simulations” Proc. of the Combustion Institute 30 (2005) 2693–2700
- [23]. Dale R.T., William B.C.” A comparison and model of NO<sub>x</sub> formation for diesel fuel and Diethyl Ether “ , SAE Paper :2001-01-0654
- [24]. Dhanasekaran, C. and Mohan Kumar, G., "Hydrogen Gas in Diesel Engine using DEE as Ignition Source," SAE Technical Paper 2012-32-0013, 2012
- [25]. Masoud Iranmanesh, "Combustion Analysis and Study on Smoke and NO<sub>x</sub> Emissions of Diesel and Biodiesel Fueled CI Engines with Ethanol Blends", Proc. of the ASME I.C.Engine Division 2009 Fall Technical Conference ICEF2009, Sept. 20-24, 2009, Lucerne, Switzerland
- [26]. Brent Bailey, Steve Guguen, Jimell Erwin, “Diethyl Ether (DEE) as a Renewable fuel” SAE Paper:972978
- [27]. Masoud Iranmanesh, J.P.Subrahmanyam, M.K.G.Babu, "Potential of Diethyl ether as supplementary fuel to improve combustion and emission characteristics of diesel engines", SAE paper 2008-28-0044

- [28]. Mohanan P. "Effect of Diethyl Ether on the Performance and Emission of a 4 - S Di Diesel Engine " SAE Paper No.2003-01-0760
- [29]. Kegl, B. and Stanislav, P., "Influence of Biodiesel on Injection, Fuel Spray and Engine Characteristics", 2008, Thermal Science: Vol. 12, No. 2, pp. 171-182
- [30]. Nurun Nabi M.D., Masahiro Minami, Hideyuki Ogawa and Noboru Miyamoto "Ultra Low Emission and High Performance Diesel Combustion with Highly Oxygenated Fuel" SAE Paper 2000-01-0231
- [31]. Subramanian, K.A.; Ramesh, A. "Operation of a compression ignition engine on diesel-diethyl ether blends" ASME Intern Combust Engine Div Publ ICE Volume:v 39 ,Publication year:2002 ,Pages:p 353-360
- [32]. P. Q. E. CLOTHIER P.Q.E., MOISE A., and H. O. PRITCHARD " Effect of Free-Radical Release on Diesel Ignition Delay Under Simulated Cold-Starting Conditions" COMBUSTION AND FLAME 81: 242-250 (1990)
- [33]. De-gang Li, Huang Zhen, Lü Xingcai, Zhang Wu-gao and Yang Jian-guang "Physico-chemical properties of ethanol–diesel blend fuel and its effect on performance and emissions of diesel engines" Renewable Energy, Volume 30, Issue 6, May 2005, Pages 967-976
- [34]. Boehman, A.L., Morris, D. and Szybist, J., "The Impact of the Bulk Modulus of Diesel Fuels on Fuel Injection Timing", 2004, Energy Fuels, 18 (6), 1877 -1882
- [35]. Ekelund, M., Egnell, R., and Gabrielsson, R., "Natural gas a fuel for reciprocating engines (in Swedish)" STU Information nr 751 – 1989. ISBN 91-7850-317-5.
- [36]. He, B.Q., Wang, J.X., Yan, X.G., Tian, X., Chen, H., "Study on combustion and emission characteristics of diesel engines using ethanol blended diesel fuels", 2003, SAE Technical Paper 2003-01-0762
- [37]. Huang, Z. H., Jiang, D.M., Zeng, K., Liu, B. and Yang,Z.L., "Combustion characteristics and heat release analysis of a direct injection compression ignition engine fuelled with diesel–dimethyl carbonate blends", IMechE 2003 Proc. Vol. 217 Part D: J. Automobile Engineering
- [38]. Baril, S., Yu, C W and Lim, T H, "Effect of fuel injection timing with waste cooking oil as a fuel in a direct injection diesel engine", 2004, Proc. IMechE Vol. 218 Part D: J. Automobile Engineering
- [39]. Heywood, J. B., "Internal combustion engine fundamentals", 1988, New York: McGraw-Hill

### Abbreviations

BMEP	Brake Mean Effective Pressure
BSCO	Brake Specific Carbon monoxide
BSEC	Brake Specific Energy Consumption
BSFC	Brake Specific Fuel Consumption
BSHC	Brake Specific Hydrocarbon emissions
BTE	Brake Thermal Efficiency
D-E-DEE	Diesel-Ethanol-Diethyl ether blend
E-Diesel	Ethanol-Diesel blend
HRR	Heat Release Rate
LFOR	Lean Flame Out Region
SOC	Start Of Combustion

### Nomenclatures

Aw	Total Surface Area Exposed To Gases
hc	Heat Transfer Coefficient.
N	Engine speed
Qch	Gross Heat Release
Qht	Heat Loss to the cylinder walls
Sp	Mean Piston Speed
Tg	Temperature Of Gas
Tw	Effective Wall Surface Temperature
U	Internal Energy
V $\Theta$	Instantaneous Cylinder Volume