

Fault Detection and Isolation of Vehicle Driveline System

M. shahab^{1,*} and M. Moavenian²

¹ Ph.d. student, ² Associate professor, faculty of Mechanical Engineering, Ferdowsi University of Mashhad, Iran.

* ma_shahab@yahoo.com

Abstract

Vehicle driveline system and its working accuracy play an important role in the performance of car. The purpose of this study is to provide an appropriate mechanism for investigating, identifying and determining the position and size of defects in the vehicle power transmission system. This is based on the patterns of the residual signal, obtained from a simulated model of the system. Neuro-fuzzy networks have been used in diagnosis of defects because of its specific advantages and capabilities in pattern recognition. Simulation results demonstrate that the resulting fault detection system is able to properly locate the fault types under all test conditions, and is sensitive also to fault size. Test and simulation results using MATLAB software is given at the end.

Keywords: Driveline systems, Simulation, Neuro-fuzzy network, Fault Detection and Isolation (FDI)

1. INTRODUCTION

Soft computing prospers well with low accuracy and approaches problem solving based on the human mind. The guiding principle of soft computing is utilization of low-accuracy characteristics to solve the problem and reduce solution costs. Since the methods using soft computing concepts are considered as powerful techniques in design of diagnostic systems, this research is based on it, having special advantages and features like high accuracy in detecting defects, determining the size of defects and the ability to use wavelet transform in obtaining residuals characteristics and improving efficiency.

In the past decade, artificial neural networks have been widely used for detection and isolation of damage in systems. Various fault detection and isolation techniques began by different researchers in the early 1970's, and several FDI methods based on analytical redundancy have been reported since then. These different techniques can be categorized to various general methods such as the parameter estimation, the parity space, the state estimation and the fault detection filter method. Most of the model-based patterns use quantitative models to estimate the states, system parameters or outputs of the system in order to generate necessary error signals [1].

A main problem associated with such methods is that, in practice, it is almost impossible to obtain a model that exactly matches the process treatment because these methods are mostly limited to linear

systems. Consequently, there is an increasing tendency for reliable methods of fault detection and diagnosis for non-linear systems [2]. To solve the above nonlinearity problem, the research of fault detection methods has, in recent decades, entered into a new season by advances of soft computing concepts such as fuzzy logic, artificial neural networks and genetic algorithms.

The main advantage of fuzzy logic systems is to treat system behavior using a set of if-then relations using both qualitative and quantitative information, i.e. both knowledge and experience of experts and measured data respectively [3]. For example, fuzzy decision-making systems were used in residual evaluation and also fuzzy rules to either assist or replace the use of a model for diagnosis [4]. Also, different applications have shown the ability of artificial neural networks to design suitable FDI systems in connection with both predictors of dynamic nonlinear models as well as pattern classifiers.

Smarter and more capable FDI structures can be expected from combining the learning capability of artificial neural networks, the transparency and interpretability of fuzzy systems, as well as the optimizing capability of genetic algorithms [5,6]. Considering both problems of residual generation and evaluation, a soft computing based architecture is suggested. In particular, a fuzzy-neural FDI structure is suggested that uses for estimation of fault location and fault size. The suggested method is then applied to diagnose the fault components of a driveline system.

In order to use the capabilities of neural networks in system training and fuzzy systems in approximate reasoning, ANFIS fuzzy-neural systems and fuzzy clustering techniques have been used in design of fault detection systems [7,8]. In this paper, due to high reliability demands of such vehicle system components, recent fault detection and diagnosis concepts for these systems are of particular importance [9]

Attention to driveline system components and their role in the performance of vehicles, assessment of the situation is important. This is a complex assembly of active and reactive dynamic elements. The driveline is highly non-linear and lightly damped, and thus readily excited by engine and road inputs. The driveline is a source of noise, vibration and harshness.

Diagnostic system investigates the health of system performance and tracks the defects according to the information received from the desired output signals, using intelligent methods. Employing a distributed-lumped elements (Hybrid) model for the vehicle driveline, validity previously proved [10], plays an important role in the accuracy of results and the fault

detection in the most of parameter of system makes it possible. It should be noted that most research in this area, are related to other vehicle system parts and components, such as the engine, suspension, braking and ..., so straight comparison with other works is not possible at this stage.

The organization of the paper is as follows. The driveline system and application of the proposed FDI scheme for component faults are described in Section 2. The proposed FDI approach is described in section 3. Section 4 includes simulation results that demonstrate the significance of the approach and conclusion at the end.

2. DRIVELINE MODEL DESCRIPTION

The vehicle driveline system comprises of engine, clutch, transmission system, drive shafts (propeller shaft), differential, rear axles and wheels. Figure 1 shows a typical automotive driveline system for a conventional rear wheel drive vehicle.

The power generated by the internal combustion engine is transmitted to the road wheels through the driveline system, sometimes referred to as a power train or drive train.

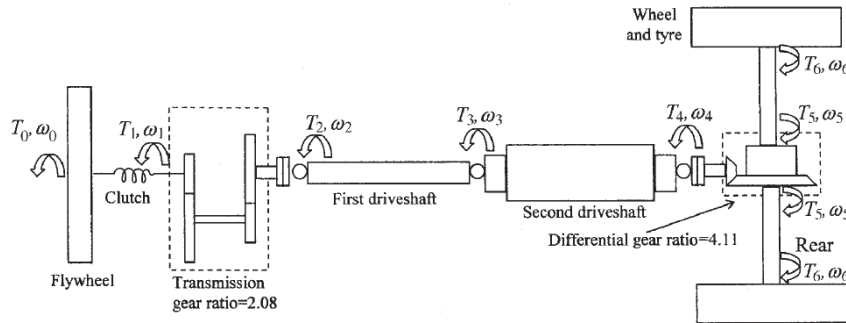

Fig. 1. Automotive driveline system for a conventional rear wheel drive vehicle [10]

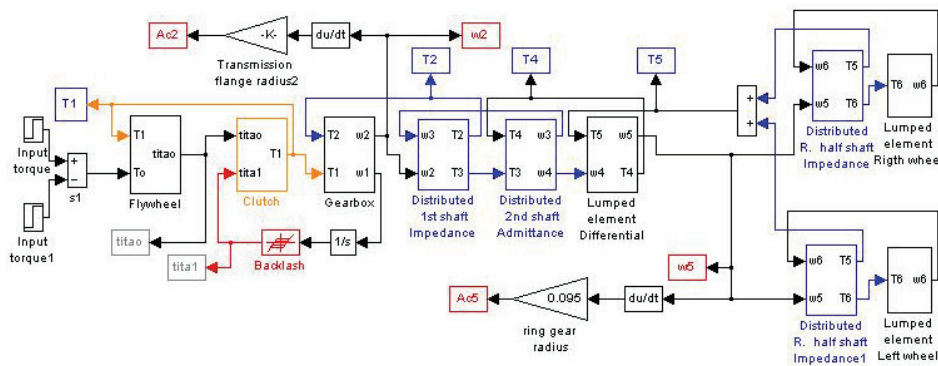

Fig. 2. The Distributed-Lumped model block diagram for the vehicle driveline system

Table 1. Nominal Parameters of Driveline System

PARTS	CHARACTERS	PARAMETERS	VALUES
Flywheel	inertia	J_f	0.3076 kg m ²
	equivalent damping	B_f	0.2 N m s/rad
	Input torque	T_0	150 Nm
Clutch	Stiffness	k_c	527 Nm/rad
	Damping	C_c	10 Nm/rad
Gearbox	inertia	J_g	0.003 kg m ²
	equivalent damping	B_g	2 N m s/rad
	Gear ratio	n_g	2.08
Differential	inertia	J_d	0.0265 kg m ²
	equivalent damping	B_d	1.0 N m s/rad
	Gear ratio	n_d	4.11
First driveshaft	length	l_1	0.435 m
	inertia	J_1	1.53×10^{-7} kg m ²
Second driveshaft	length	l_2	0.985 m
	inertia	J_2	1.19×10^{-6} kg m ²
	shear modulus	$G_1 = G_2$	80×10^9 N/ m ²
	damping	C_p	0 Nm/rad
Axle halfshaft	length	l_3	0.877 m
	inertia	J_3	7.95×10^{-8} kg m ²
	shear modulus	G_3	77.3×10^9 N/ m ²
	damping	C_a	0 Nm/rad
Wheel	Inertia	J_w	2 kg m ²
	damping	B_w	1×10^{15} Nms/rad
	density	ρ	7810 Kg/ m ³

A clutch is usually mounted in the bell housing between the flywheel and the input shaft of the gearbox. The role of the clutch is to permit the drive to be engaged and disengaged. Transmission and differential which ensure necessary reductions from the engine speed to the required speed at the road wheels. The gearbox includes a large number of gears for speed reduction. The propeller shaft is an assembly of various components, including the driveshafts, constant velocity joints and spine joints. The differential effects a 90 degree transfer of power to rear axles which engage wheel spindles.

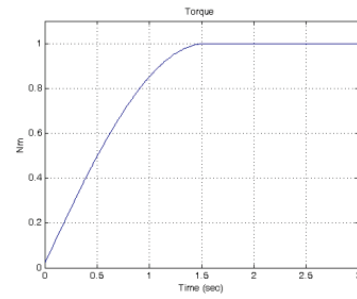

Fig. 3. Output torque from the engine

There are many configurations for driveline system, depending on vehicle type; front wheel drive, rear wheel drive or four wheel drive, as well as manual transmission versus automatic transmission, small car as opposed to vans and light trucks, and through to heavy goods vehicles.

The behavior of a lumped dynamic system is governed by a set of ordinary differential equations. The dynamic behavior of a distributed system can be similarly stated and governed by a set of partial differential equations. Physically all systems are distributed in nature, but for practical purposes they can be approximated by ordinary differential equations or by a combination of distributed and lumped components.

In this study the distributed-lumped (hybrid) modeling technique (DLMT) is considered for solving the equations of motion. The block diagram method and the transfer function method (TFM) will be used for time and frequency responses of the model respectively. For modeling of the non-linear parameters, the describing function technique will be applied to the driveline model. (To increase the accuracy and efficiency) [10]

This model was simulated in MATLAB using the

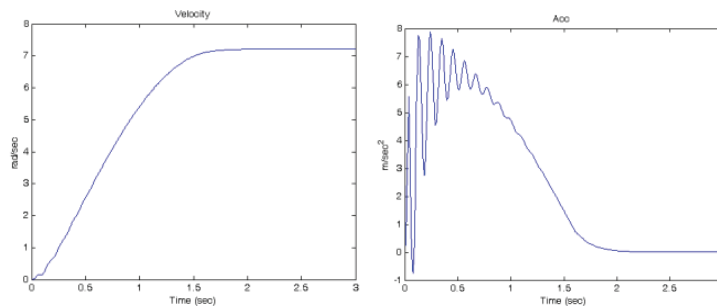

Fig. 4. Vehicle wheel angular velocity and acceleration

SIMULINK toolbox for a light diesel truck with a two piece propeller shaft. The block diagram for the vehicle driveline used in fault detection is shown in Fig. 2.

Output torque of the engine is considered as input and angular velocities and accelerations of vehicle wheel as two system outputs. (These signals were selected because they are easily measurable).

Table 1 shows the nominal parameters of driveline system. Twelve parameters could cause known fault conditions within the system. These parameters are k_c , C_c , BL , B_g , n_g , B_d , n_d , C_a , J_g , J_f , B_f and J_d .

Input and output signals are obtained by the simulation model and are representatives of normal system behavior. The figures are given below (Fig. 3, 4).

3. THE PROPOSED FDI APPROACH USING NEURAL NETWORKS - FUZZY

A system that has the capacity of detecting, isolating, identifying or classifying faults is called a fault diagnosis system. According to generally accepted terminology, the fault diagnosis task consists of the following three steps: fault detection (indicates that an abnormal behavior has occurred), fault isolation (determines the type and location of the failure), and fault analysis (determines the relation between symptoms and cases of failures). Furthermore, there are two general opinions in design of model-based FDI techniques as follows:

1. Generation of serious residuals and symptoms that contain rich and satisfactory information about faults. If such symptoms are not generated successfully, certain fault features could potentially be lost. (Residual evaluation becomes relatively easy if residuals are well designed)
2. Designing powerful fault detection systems

using sophisticated techniques, which reflect fault specification and adopt a reliable, safe and optimal decision accordingly, even if the residuals are not well-designed.

In this paper, we demonstrate that a combination of the above two viewpoints can have potentially significant. Improvement to FDI systems, namely, in the proposed soft computing based diagnosis system, because of the successful clustering based modeling, the residuals regarding specific faults have uniquely recognizable patterns. Consequently the residuals are well-designed, and a robust diagnosis system for residual evaluation can be designed.

The proposed fault detection method is based on the following:

- a. Modeling the normal state of the system.
- b. Generating the residuals.
- c. Alerting the occurrence of faults in case of significant differences
- d. Identifying the location and size of faults.

Normal state of the system is determined using a simulated model. For determination of the fault location and size, ANFIS fuzzy-neural decision making system has been used.

This structure is the major training routine for Sugeno-type fuzzy inference systems. Anfis uses a hybrid learning algorithm to identify parameters of Sugeno-type fuzzy inference systems. It applies a combination of the least-squares method and the back propagation gradient descent method for training FIS membership function parameters to emulate a given training data set. Anfis can also be invoked using an optional argument for model validation [11].

Figure 5 demonstrates a schematic representation of the system. In order to detect the position and size of defects using defects signs, a fuzzy-neural based system has been designed for estimating the position

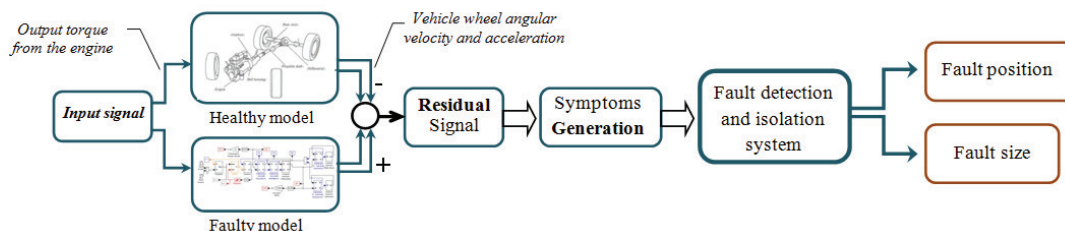

Fig. 5. General Schematic of Proposed FDI

of defects.

The input of system is extracted features from the residual data and the system output indicates the fault condition. By changing the desired simulated system parameters for fault detection, the remainders, which are the differences of the output signals of the simulated and the identified system, reveals different patterns. This will make it easy to identify and isolate defects [12,13].

Using the samples of the residual signals (healthy condition), as input data to the neural network, prolongs the process of network training and causes bulkiness, plus heavy dependence of results to the signal amplitude and high sensitivity to noise. Therefore, to detect defects in the system parameters, the salient features of any remainders signal, are derived as signs of defects.

Some of the significant and more effective features are: Maximum, Minimum, Average, Standard deviation, Stretch and Skewness of residual signal's, using wavelet toolbox and signal frequency characteristics. [14,15]

The most important advantages of this network are its compound learning rules and comprehensible output, making it more efficient than other methods. To implement the technique, first, a set of rules should be introduced, so that during training period the system optimizes shape of membership functions in the hypothesis part and also optimizes parameters of the rules part outcomes. The importance here is that attention should be paid to find appropriate required data for the system. As a result, adequate membership functions and rules of "if – then" can be chosen for it.

Characteristic signs of defects that have been obtained in the previous step are considered as input to the decision-making systems. If these features belong

to a class of defects, the system output will identify the number that represents the fault. The defects size estimation is carried out after identification of any fault by neural network.

It should be mentioned that, sometimes and in some circumstances, selecting the type of membership functions in fuzzy systems is difficult. However, the membership functions shape depends on some parameters and varying these parameters will change the shape of membership functions. Use of adaptive neural learning techniques can be very useful in choosing optimal membership functions.

This method of learning is very similar to neural networks and it is applied by passing the training data through an optimal system of membership functions to match with the data shape and to model the behavior of the data.

After forming the membership functions and supposed "if – then" rules of the system, the network is then taught. Network training continues until the error is minimized and the system is properly optimized. Usually by increasing the number of iterations, the error decreases.

4. SIMULATION RESULTS

Angular velocities and accelerations of vehicle wheel are two outputs of the driveline system. These two outputs were chosen as fault indications and residuals are generated by inconsistency between the faulty model and the nominal (free-fault) model.

In the present work, faults are simulated on the process model that was validated in part by comparing actual experimental data with simulation. Namely the data extracted by this model are used to simulate the trained (known) faults.

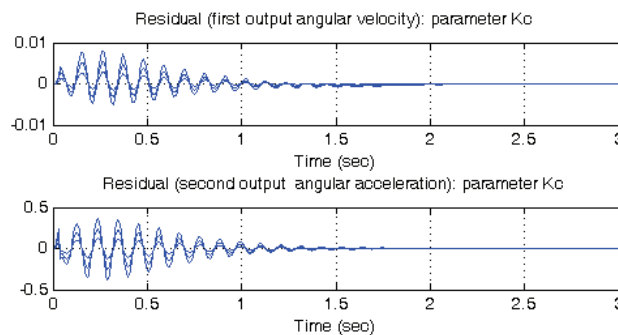

Fig. 6. Residual signals patterns of velocity and acceleration output with different values for parameter K_c (clutch)

In this paper, all faults were emulated in software by applying suitable changes to the parameters of driveline system in nominal (free-fault) condition. Each fault type is simulated at various size levels, varying from 2 to 60 percent. The resulting pairs of fault types and their symptoms have been used for design of the local fuzzy agents.

A model based on system identification method is used to estimate the nominal process output signals. (When the system is working under healthy condition)

Because of space limitation, some residual signal patterns of velocity and wheel angular acceleration in the parts of flywheel, clutch, gearbox, differential, shaft and wheel, with different values which obtained from the Simulation result, are shown in Fig.6-9. (Residual signals patterns and different faults for fault size of each of two outputs.)

Residuals are produced as difference of healthy output signals and faulty output signals of the nominal process. In these figures, velocities and accelerations

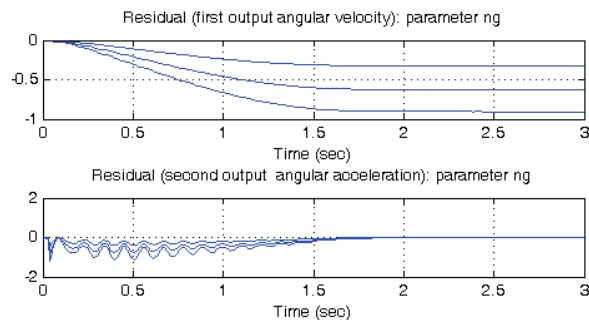

Fig. 7. Residual signals patterns of velocity and acceleration output with different values for parameter ng (gearbox)

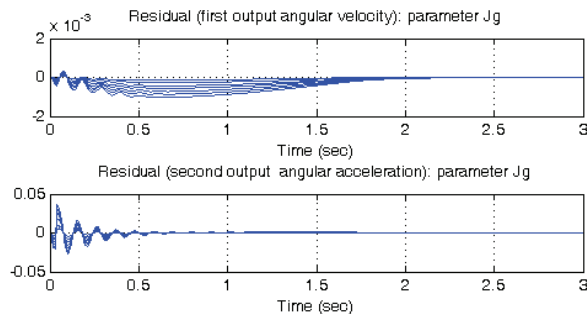

Fig. 8. Residual signals patterns of velocity and acceleration output with different values for parameter Jg (gearbox)

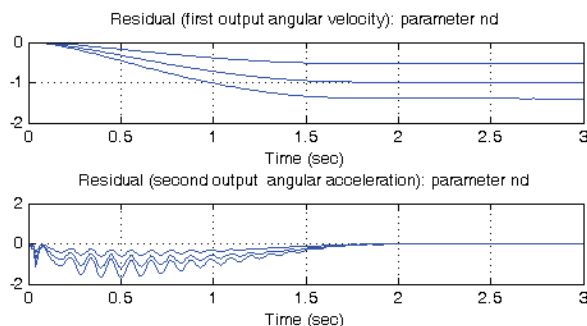

Fig. 9. Residual signals patterns of velocity and acceleration output with different values for parameter nd (differential)

describe the residuals regarding 1st and 2nd outputs, i.e. angular velocities and accelerations of vehicle wheel, respectively.

In these figures, the residuals regarding changes of a specific parameter have a unique pattern and on the other hand have a different pattern than residuals regarding change of other parameters.

From the simulated results, the residuals are

corrupted with noise and hence a fuzzy detection system is a reasonable way for handling this uncertainty and for proper diagnosis of faults. Several symptoms are extracted for fault diagnosis.

Following the symptoms generated, a suitable decision mechanism has been designed to localize the fault based on Neuro-fuzzy networks. The networks approach for the fuzzy agents is to create membership functions of fuzzy

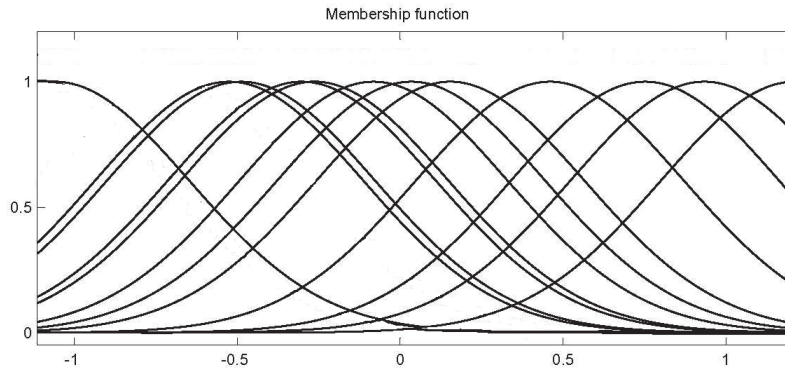

Fig. 10. Fuzzy membership function of residual signals for diagnostic system second input

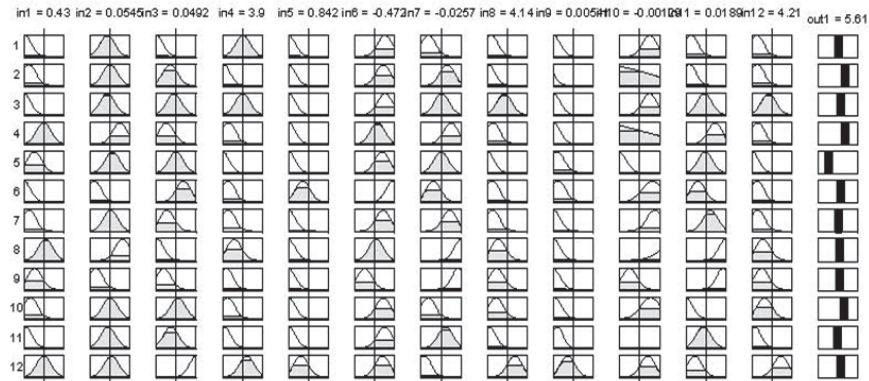

Fig. 11. Structure of the Sugeno fuzzy diagnostic system

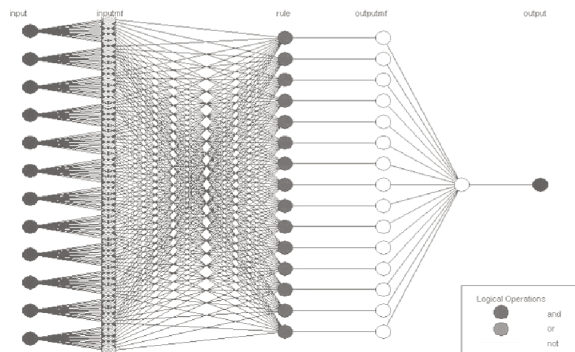

Fig. 12. The model structure of neural fuzzy systems

Table 3. Estimated accuracy of the driveline model parameters

Method	Type of clustering	Adjustment method of Membership functions	Error
Neuro-fuzzy networks (ANFIS)	FCM	Hybrid	7.23 %
		Back propagation	8.12 %
	Subtractive	Hybrid	4.56 %
		Back propagation	13.61 %
Neural Networks	RBF (Radial Basis Neuron)		11.14 %
	MLP (multilayer perceptron)		15.86 %

sets which have the appropriate interval of universe of discourse for each of twelve inputs.

Figures 10 and 11 show the membership functions of residual signals and structure of the Sugeno fuzzy diagnostic system for twelve inputs, respectively (the FDI contains one “if-then” rule for each agent as shown in the following case studies). The characteristics of variables are used to describe the states of the subsystems as follows: Maximum,

Minimum, Average, Standard deviation, Stretch and Skewness of residual signal’s, using wavelet toolbox and signal frequency characteristics.

Number of inputs in the decision making system is identified according to the number of features extracted from the signals and the number of system outputs. Fig 12 shows, the structure of neural fuzzy networks for fault detection system.

In this section, the effect of different modes on fault detection system performance, such as the types of neural networks, the number of parameters and system outputs, the signal characteristics and using wavelet transform on the accuracy of detecting faults is investigated. Then the best is selected to build the FDI system.

A comparison of error in fault detection system for neural networks and neuro-fuzzy networks, with different kinds of clustering types, see table 2. Least error (4.56 %) for fault detection is achieved by ANFIS (Hybrid). Therefore this method is more accurately in fault tracking and selected to design the FDI system

In order to validate and prove the capability of the proposed ‘FDI’ system, the study is divided into two phases:

1. Design and development of the fuzzy neural diagnostic system (including healthy, faulty and residual production plus establishing fault y symptoms generation and teaching the system).
2. Testing the proposed FDI system (Feeding the system with different faulty system signals and observing the response of FDI system).

After finishing the diagnostic system design, in the

Table 3. Estimated accuracy of the driveline model parameters

Parameter	# of test	# of correct classifications	Performance	confidence interval [$\alpha = 0.1$]	Average error of fault size
k_c	30	28	97	$0.84 < p < 1$	0.051
C_c	30	27	90	$0.79 < p < 1$	0.113
BL	30	23	76	$0.61 < p < 0.91$	0.074
B_g	30	25	83	$0.70 < p < 0.97$	0.097
n_g	30	26	86	$0.75 < p < 0.99$	0.082
B_d	30	27	90	$0.79 < p < 1$	0.061
n_d	30	27	90	$0.79 < p < 1$	0.048
J_g	30	28	97	$0.84 < p < 1$	0.072
C_a	30	25	83	$0.70 < p < 0.97$	0.084
J_f	30	29	96	$0.9 < p < 1$	0.063
B_f	30	28	97	$0.84 < p < 1$	0.045
J_d	30	30	100	$1 < p < 1$	0.037
average	360	323	89.7	$0.865 < p < 0.928$	0.068

Performance = $100 \times (\text{\# of correct classification}) / (\text{\# of test points})$

Table 4. Influences of different mode on the estimated performance in fault tracking

	mode	Case 1	Case 2	Case 3	Case 4	Case 5	Case 6	Case 7	Case 8	Case 9	Case 10	Case 11	Case 12
Signal characteristics and outputs	output 1	●	●	●	●	○	○	○	○	●	●	●	●
	output 2	○	○	○	○	●	●	●	●	●	●	●	●
	Maximum	●	●	●	●	●	●	●	●	●	●	●	●
	Minimum	●	●	●	●	●	●	●	●	●	●	●	●
	Mean	●	●	●	●	●	●	●	●	●	●	●	●
	Standard deviation	○	●	●	●	○	●	●	●	○	●	●	●
	Stretch	○	●	●	●	○	●	●	●	○	●	●	●
	skewness	○	○	●	●	○	○	●	●	○	○	●	●
	Wavelet_symptoms	○	○	○	●	○	○	○	●	○	○	○	●
Performance of Parameter	k_c	24%	47%	54%	74%	22%	53%	53%	71%	48%	71%	76%	97%
	C_c	17%	55%	52%	62%	16%	57%	57%	65%	31%	74%	75%	92%
	BL	21%	48%	62%	73%	17%	46%	54%	73%	39%	69%	74%	75%
	B_g	20%	56%	51%	66%	22%	54%	49%	65%	38%	61%	68%	86%
	n_g	23%	53%	56%	65%	22%	55%	53%	69%	43%	73%	71%	86%
	B_d	16%	52%	58%	61%	26%	53%	54%	63%	34%	69%	73%	90%
	n_d	31%	56%	56%	73%	31%	57%	57%	71%	54%	74%	77%	88%
	J_g	33%	43%	51%	81%	34%	45%	52%	76%	53%	67%	73%	95%
	C_a	23%	49%	52%	68%	28%	52%	43%	71%	33%	58%	59%	85%
	J_f	19%	33%	59%	62%	14%	45%	62%	61%	27%	73%	69%	96%
	B_f	13%	38%	53%	64%	9%	47%	55%	62%	28%	71%	73%	98%
	J_d	28%	42%	58%	83%	41%	52%	62%	81%	62%	76%	78%	100%
	Total average	22%	47%	55%	69%	23%	51%	54%	69%	40%	69%	72%	90%

●, used in fault detection process; ○, unused in fault detection process; every column represents a case study.

testing phase, faulty signals that are generated using a known faulty model (changing the parameter values corresponding to a known fault) are employed and feed to the FDI system. These faulty signals are not similar to the signals used in the training phase, from size point of view.

The diagnostic system according to the pattern of the residual signals available in the memory, will declare the type and size of the faults.

This test was performed several times and with considering the number and the system answers, the

fault detection accuracy for each parameter is estimated (see table 3). For each fault mode, a number of different fault sizes were tested.

Considering the obtained patterns, detection of defects in components of the driveline system such as clutch, gearbox, driveshaft and differential, rear axle have been studied. Results of identified system wear and isolated defects in the system parameters k_c (Clutch stiffness), C_c (Clutch damping), BL(Gearbox gear backlash), B_g (Gearbox equivalent damping), n_g (Gearbox gear ratio), B_d (Differential equivalent

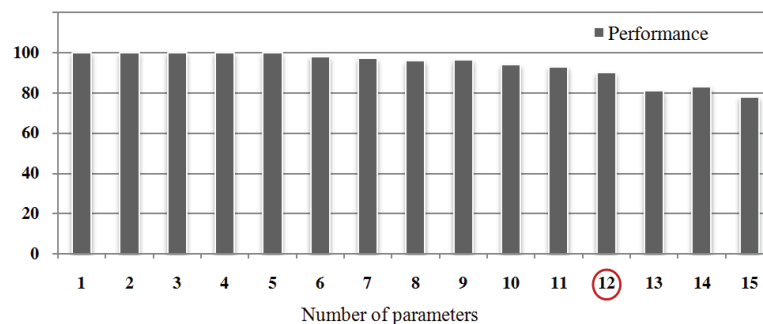

Fig. 13. Relationships the number of parameters with estimated accuracy of the diagnostic system

damping), n_d (Differential gear ratio), C_a (Axle and wheel damping), J_g (Gearbox inertia), J_f (Flywheel inertia), B_f (Flywheel equivalent damping) and J_d (Differential inertia) are given in Table 3.

The accuracy of the simulation results show that the networks estimation of the size of faulty parameters is within acceptable level. General calculations, evaluation and system estimation accuracy in fault detection of the parameters observing the above assumptions, indicates that if equal value is considered for all parameters then, calculation of the confidence interval will be as follows: [16]

$$\begin{aligned}
 n &= \text{data point} \\
 p &= \text{success (in population)} \\
 \hat{p} \ (x/n) &= \text{success (in sample)} \\
 q &= \text{failure} \\
 x &= \text{success interest} \\
 n &= 360 \\
 x &= 323 \\
 \hat{p} &= x/n = 323/360 = 0.897 \\
 q &= 1 - 0.897 = 0.102 \\
 \text{With } \alpha &= 0.05 \rightarrow Z_{\alpha/2} = 1.96 \\
 \text{Error} = E &= Z_{\alpha/2} \frac{\sqrt{p \cdot q}}{n} = 1.96 \times \sqrt{\frac{0.897 \times 0.102}{360}} = 0.0313 \\
 \hat{p} - E < p < \hat{p} + E &\rightarrow 0.865 < p < 0.928
 \end{aligned}$$

According to the results of tested samples and calculated confidence intervals, it can be said that we are 90% sure that the accuracy of fault detection for the parameters are between 92.8 and 86.5 percent. However, it should be noted that in practice, errors resulting from the gauges, environmental conditions, and other terms reduce accuracy in the process of finding the defect.

Table 4 shows how different modes affect the estimated performance and relationship between the investigated states in the proposed scheme. The changes in use of factors continue until an acceptable accuracy for fault detection system is achieved (The last column-case12).

Fig 13 illustrates the effect of number of parameters on estimated performance. It shows that increasing the number of parameters to more than twelve reduces the accuracy significantly. The increase of the number of parameters caused the networks to be extensive and large and thus increased the probability of error (Due to interference of the fuzzy membership functions of the diagnostic system, accuracy is reduced). The

results show that the accuracy of fault detection depends on a good initial judgment in selection of the factors to be used in the FDI process.

5. DISCUSSION AND CONCLUSION

The importance of vehicle driveline system and required working accuracy, initiates the need for investigation on an appropriate and practical mechanism to detect, identify and determine faults, position and size of defects in the vehicle power transmission system.

We propose a soft computing approach to design fault detection and isolation (FDI) systems for Vehicle Driveline. Neuro-fuzzy networks have been used in the diagnosis of defects because of its specific advantages and capabilities in pattern recognition and facilitate the possibility to measure the required output signals. Hybrid combination of fuzzy logic, neural networks, seems to have two consequences. Firstly, design of each agent becomes relatively trivial, and hence robust. Second, the system can be easily expanded for new fault types.

Lack of laboratory facilities, are an obstacle that prevents possibility of using signal based FDI methods, so employing a distributed-lumped elements (Hybrid) proved model for the vehicle driveline, will compensate this and replaces model based FDI method. The use of this model plays an important role in the accuracy of results and the fault detection in the most of parameter of system makes it possible.

To improve the performance, reliability, feasibility and also to reduce the cost of the FDI system, First the effect of different mode, such as the types of neural networks, the number of parameters and system outputs, the signal characteristics and using wavelet transform on the accuracy of detecting faults is investigated. Then the best is selected to build the FDI system. These results indicate the effectiveness of the practical approach depends on a good initial judgment in selection of the factors to be used in the diagnostic process.

For verification of the designed diagnostic system, in the testing phase, faulty signals are employed and feed to the FDI system. According to this result, we find the accuracy and validity of diagnostic system. Simulation results indicate that the proposed method is capable of successful detection of several component fault types and sizes of the driveline.

Specifically, the minimal detectable fault values in this system are as low as 2 percent.

It should be noted that simulation, design, analysis and calculations have been performed in the MATLAB software environment. We aimed to keep the system as realistic as possible by utilizing a system mode that had been previously experimentally verified.

REFERENCES

- [1] A. L. Dexter and M. Benouarets, "Model-Based Fault Diagnosis Using Fuzzy Matching," *IEEE Transactions on Systems, Man & Cybernetics--PART A: SYSTEMS AND HUMANS*, 27(5), 1997, pp. 673-682.
- [2] M. Sotudeh-Chafi, M. Moavenian, and M.-R. Akbarzadeh-T., "Critical Cases of a CNC Drive System – Fault Diagnosis via a Novel Architecture," *Proceedings of the NAFIPS-FLINT 2002 International Conference*, New Orleans, LA, 2002, pp. 494-499.
- [3] R. J. Patton, C. J. Lopez-Toribio, and F. J. Uppal, "Artificial Intelligence Approaches to Fault Diagnosis," *IEEE the Institution of Electrical Engineers*, Savoy Place, London WC2R OBL, UK, 1999, pp. 5/1-5/18.
- [4] A. L. Dexter, "Fuzzy model-based fault diagnosis," *IEEE Proc. Control Theory Appl.*, 142(6), 1995, pp. 545-550.
- [5] R. J. Patton, F.J. Uppal, C.J. Lopez-Tribio, *Soft computing approaches to fault diagnosis for dynamic systems: a survey*, in: IFAC Symposium SAFEPROCESS, 2000, 298–311.
- [6] M. Sotudeh-Chafi, M. R. Akbarzadeh, and M. Moavenian, "Fault Detection and Isolation in Nonlinear dynamic Systems: A Fuzzy-Neural Approach," *FUZZ-IEEE2001*, Melbourne, Australia, 2001, pp. 1072-1075.
- [7] Sushmita, M, Yoichi, H. "Neuro-Fuzzy Rule generation : survey in soft computing framework", *IEEE transactions on neural networks*, vol.11, No.3, 2000
- [8] Tolga Yu' ksel , Abdullah Sezgin "Two fault detection and isolation schemes for robot manipulators using soft computing techniques" *Applied Soft Computing* 10 (2010) 125–134
- [9] D. Fischer, M. Borner, J. Schmitt, R. Isermann. "Fault detection for lateral and vertical vehicle dynamics", *Control Engineering Practice* 15 (2007) 315–324
- [10] Farshidianfar, A. "optimisation of torsional vibrations in driveline system"s, university of Bradford, UK, 2001
- [11] Jang, J.-S. R., "ANFIS: Adaptive-Network-based Fuzzy Inference Systems," *IEEE Transactions on Systems, Man, and Cybernetics*, Vol. 23, No. 3, pp. 665-685, May 1993.
- [12] Shahab. M, moavenian. M. "design of fault detection system based on soft computing concepts for machine tool drive system simulated by hibrid modeling". *ISME2007,Tehran, iran,2007*, 1517 (in Persian)
- [13] Moavenian, M ,Sotudeh, M , Akbarzadeh, M,R " Using of Modeling based on Soft Computing in designing of a FDI system for a CNC X-axis Drive:Part II-Fuzzy-based and Neuro-Fuzzy based Modeling ," In proc. 6th Int Conf. *ISME2001,Tehran,Iran, May.2002*, PP. PP.899-906. (In Persian)
- [14] C.K Sung, C.W.Chen ,2000 ,*Locating Defects of a Gear System by the Technique of Wavelet Transform*, Mechanism and Machine Theory, New York, McGraw-Hill
- [15] Inan Guler, Elif Derya Ubeyli, "Adaptive neuro-fuzzy inference system for classification of EEG signals using wavelet coefficients" *Journal of Neuroscience Methods* (2005)
- [16] Douglas C. Montgomery, George C. Runger "Applied Statistics and Probability for Engineers" Third Edition, Copyright 2003 © John Wiley & Sons, Inc.